

**GENERAL MEETING OF THE BOARD OF DIRECTORS
OF THE
CENTRAL TEXAS REGIONAL MOBILITY AUTHORITY**

RESOLUTION NO. 14-059

**APPROVING A WORK AUTHORIZATION WITH TELVENT USA, LLC,
FOR TOLL SYSTEM DESIGN AND INTEGRATION SERVICES
FOR THE SH 71 EXPRESS PROJECT.**

WHEREAS, the Central Texas Regional Mobility Authority ("Mobility Authority") entered into a contract with Caseta Technologies, Inc. dated April 27, 2005, for the design, procurement, and installation of a toll collection system on the Authority's turnpike system (the "Contract"); and

WHEREAS, Caseta Technologies, Inc., was subsequently acquired by Telvent USA Corporation, a Maryland corporation ("Telvent"), and all rights and obligations of Caseta Technologies, Inc. under the Contract are now the rights and obligations of Telvent; and

WHEREAS, Telvent is providing toll system implementation services for the MoPac Improvement Project and other projects under work authorizations previously authorized by the Board under the Contract; and

WHEREAS, the Executive Director and Telvent have discussed and agreed to a proposed work authorization for Telvent to provide toll system design and integration services for the SH 71 Express Project; and

WHEREAS, the Executive Director recommends approval of the proposed work authorization attached as Exhibit 1.

NOW THEREFORE, BE IT RESOLVED that the proposed work authorization is hereby approved; and

BE IT FURTHER RESOLVED that the Executive Director may finalize and execute for the Mobility Authority the proposed work authorization in the form or substantially the same form as Exhibit 1.

Adopted by the Board of Directors of the Central Texas Regional Mobility Authority on the 30th day of July, 2014.

Submitted and reviewed by:



Andrew Martin
General Counsel for the Central
Texas Regional Mobility Authority

Approved:



Ray A. Wilkerson
Chairman, Board of Directors
Resolution Number: 14-059
Date Passed: 7/30/2014

EXHIBIT 1 TO RESOLUTION 14-059
PROPOSED WORK AUTHORIZATION

[on the following 49 pages]

CENTRAL TEXAS REGIONAL MOBILITY AUTHORITY

WORK AUTHORIZATION

WORK AUTHORIZATION NO. 12

TOLL SYSTEM IMPLEMENTATION

SH 71 TOLL LANES PROJECT

THIS WORK AUTHORIZATION (“WA No. 12”) is made pursuant to the terms and conditions of Article 1 of the GENERAL PROVISIONS, Attachment A to the original Contract for Toll System Implementation, dated April 27, 2005 (the Contract) entered into by and between the Central Texas Regional Mobility Authority (the “Authority” or “CTRMA”), and TELVENT USA, LLC (the “Contractor,” also referred to in attachments to this WA No. 12 as the “System Integrator” or “SI”).

PART I. The Contractor will perform toll implementation services generally described in the Scope of Work attached hereto as Attachment A. The Contractor’s duties and responsibilities are further detailed in: (1) the SH 71 Toll Lanes Project Layout included as Attachment B, (2) the Toll Facility Responsibility Matrix included as Attachment C, and (3) the Fixed Price Tolling Standards included as Attachment D.

PART II. The maximum amount payable under this WA No. 12 is \$ 2,059,495. This amount is based upon the pricing obtained, and is documented by the fee schedule set forth in Attachment E

PART III. Payment to the Contractor for the services established under this WA No. 12 shall be made in accordance with the Contract.

PART IV. This WA No. 12 shall become effective on the date both parties have signed this WA No. 12. This WA No. 12 will terminate on the SH 71 Toll Lanes substantial completion date or upon payment of the maximum amount payable in **Part II**, whichever date is first, unless extended as provided by the Contract. The work shall be performed in accordance with the Project Schedule and Milestones as set forth in Attachment F.

PART V. This WA No. 12 does not waive any of the parties' responsibilities and obligations provided under the Contract, and except as specifically modified by this WA No. 12, all such responsibilities and obligations under the Contract remain in full force and effect.

IN WITNESS WHEREOF, this Work Authorization No. 12 is executed in duplicate counterparts and hereby accepted and acknowledged below.

THE CONTRACTOR: Telvent USA, LLC.

Signature _____ Date _____

Typed/Printed Name and Title _____

CENTRAL TEXAS REGIONAL MOBILITY AUTHORITY

Executed for and approved by the Central Texas Regional Mobility Authority for the purpose and effect of activating and/or carrying out the orders, established policies or work programs heretofore approved and authorized by the Texas Transportation Commission.

Signature _____ Date _____

Mike Heiligenstein, Executive Director
Typed/Printed Name and Title _____

LIST OF ATTACHMENTS

- | | |
|--------------|---------------------------------------------|
| Attachment A | Scope of Work |
| Attachment B | SH 71 Toll System Layout |
| Attachment C | Toll Facility Responsibility Matrix |
| Attachment D | Fixed Price Tolling Standards |
| Attachment E | Fee Schedule/Budget |
| Attachment F | Preliminary Project Schedule and Milestones |

ATTACHMENT A**CENTRAL TEXAS REGIONAL MOBILITY AUTHORITY
TOLL SYSTEM IMPLEMENTATION
State Highway 71 Toll Lanes Project****SCOPE OF WORK for SYSTEMS INTEGRATOR****A1.0 General****A1.01. Background**

The Texas Department of Transportation ("TxDOT") is developing the SH 71 Toll Lanes Project ("Project"), which will consist of adding toll lanes to SH 71 from Presidential Boulevard to east of SH 130, and will include the realignment of FM 973 where that road intersects with SH 71. The project length is approximately 4 miles. TxDOT will be developing the project in cooperation with the Central Texas Regional Mobility Authority ("Authority"), with TxDOT taking the lead in the design, permitting, and construction of the Project, and the Authority responsible for the design, procurement, permitting, installation, testing and commissioning of the Toll Collection System (TCS), which will include but not necessarily be limited to tolling equipment, cameras, antennas, fiber optic system, and the supporting electrical system.

Upon substantial completion, the Authority shall operate and maintain toll lanes on the Project, which will include the collection of tolls, setting toll rates, servicing customers, toll enforcement, facilities and toll collection system maintenance, repairs and capital improvements to the toll lanes, toll facilities, and related equipment. TxDOT shall operate and maintain the general purpose lanes and the FM 973 realigned intersection with SH 71.

A1.02. Summary Scope of Work

The Scope of Work for Work Authorization No. 12 provides for the procurement, installation, testing, and implementation of a complete and fully operational TCS for the Project by the Systems Integrator (SI), including all of the required communications and systems interfaces including design, coordination, and project interface activities to facilitate the design and construction of the toll system infrastructure facilities by others on the SH 71 Toll Lanes Project.

This Work Authorization also authorizes the SI to establish and maintain relationships with a wide variety of third parties and to coordinate the designs for the proposed TCS with the entire Hwy 71 Toll Project to ensure that the construction of the toll system infrastructure facilities will be fully compatible and will meet the requirements for the CTRMA's TCS. In this role, the SI will work closely with CTRMA, TxDOT, and various designers and roadway contractors in developing the required complete TCS and network infrastructure.

A2.0 General Description – Toll Road Infrastructure and Site

The SH 71 Toll Lanes Project limits extend from Presidential Boulevard to east of SH 130, and will include the realignment of FM 973 where that road intersects with SH 71. The project length is approximately 4 miles.

The existing roadway in the vicinity of the preliminary location of the toll gantries includes three 12-ft lanes in each direction with a depressed grassed median. Right-of-way width varies from 220 to 280 feet.

Proposed Facility: The proposed work for the entire toll road facility will consist of the following:

- Adding two new toll lanes (one in each direction) from Presidential Boulevard to SH 130; Number of toll lanes approaching FM 973 and at the gantry location increases to four lanes (two in each direction), and
- Constructing bridges over FM 973 and SH 130 and connecting ramps between the new express toll lanes and the mainlanes of SH 71 and SH 130; and
- Widening of SH 71 between Presidential Boulevard and FM 973

The Toll Collection System (TCS) for the Project will be all Electronic Toll Collection (ETC). The entire full build project will consist of four (4) gantry lanes at the locations listed in Table 1 below. Locations are approximate and may be subject to change as the CDA Developer progresses towards the completion of plans development.

Table 1: Gantry Locations and Lane Counts

Approximate Station Location	Direction of Travel	No. of Lanes	No. of Shoulders (8' or greater)	Comments
11150+00	Westbound	2	2	The preliminary schematic typical section includes 10 foot shoulders on either side. However, the typical section may be different if the location of the gantry is revised.
11150+00	Eastbound	2	2	The preliminary schematic typical section includes 10 foot shoulders on either side. However, the typical section may be different if the location of the gantry is revised.
Total Gantry Lanes		2	4	

Refer to the SH 71 Toll Lanes Project Layout included as **ATTACHMENT B** for the general project layout.

A3.0 General Requirements - Toll Collection System

The TCS for the CTRMA Turnpike System, which is being designed and implemented through a series of separate work authorizations for the various segments of the proposed Toll Road System, generally will be fully compatible with the TCS which has been designed and implemented for the 183A Toll Road and the Manor Expressway Projects, using automatic vehicle identification and classification technology, a Violation Enforcement System (VES) with an integrated camera and triggering system to capture referenced digital images of license plates, and a Remote Online Management System (ROMS). It is required that the TCS be interoperable with the other Texas ETC systems.

The Customer Service Center (CSC) is located in a facility at 12719 Burnet Road, Austin, Texas, developed and administrated by the Toll Operations Division (TOD) of TxDOT. The CTRMA contracts with the members of the Texas Statewide Interoperability Task force for CSC services for its customers. Expansion of CTRMA's TCS to serve the Hwy 71 Toll Project includes coordination and design of appropriate interfaces with the CSC. Appropriate communications links between the various toll facilities on the CTRMA Toll Road System and the CTRMA Administrative Offices, the future Traffic Management Center (TMC) at the Field Operations Building(s) and the Violation Processing Center (VPC) are part of the requirements of the design/implementation work.

The VPC is located in a separate facility, and is being administrated by the Municipal Services Bureau, Inc. under contract to the CTRMA. Development of CTRMA's TCS also will include coordination and design of appropriate interfaces with the VPC. Appropriate communications links between the various toll facilities on the CTRMA Toll Road System, the CTRMA Administrative Offices, the 183A Field Operations Building and the CSC are part of the requirements of the design/implementation work.

A4.0 Equipment and Installation – Gantries and Roadside Equipment

For all TCS field installations on the various segments of the Hwy 71 Toll Project, the SI will be required to provide and install the toll equipment systems and hardware for a complete, tested, and operating TCS under this Work Authorization. The principle items of work and primary components of the TCS at each Remote Toll Location will include, but are not limited to:

- Furnish & Install Lane Controllers and ancillary devices
- Furnish & Install ETC Lane components, including AVDS, AVC, VES, TSI and AVI systems and hardware.
- Furnish & Install all ETC Lane Equipment wiring & cable, hardware, brackets, and fasteners required to attach the ETC equipment to the gantries provided by the others.
- Furnish & Install ROMs monitoring for all ETC site equipment (i.e.: ETC Equipment, AVDS, AVC, AVI, VES, HVAC, generators, power, communications equipment, etc)
- Communication System Outside Fiber Optic Cable Plant, Inside Cable Plant, and Network Components (i.e.: Fiber Optic Cable, Terminations, Switches, routers and other network devices)
- Furnish & Install Master Ground System connected to the Master Ground Bus Bar provided by others
- Furnish & Install Lightning Surge Suppression System & Components for AVI, network, VES, UPS power, and service/feeder power.
- Furnish & Install Backup Electrical Power including Emergency Generators, Fuel Tanks, and Automatic Transfer Switches.
- Furnish & Install Uninterruptible Power Supply, including wiring & cable, hardware, and ROMs interface
- Furnish & Install In-Lane Processor (ILP) enclosure, with HVAC for appropriate environmental protection and climate controls for electronic equipment. Furnish & Install Site Surveillance Cameras & Security Systems to monitor each ILP and gantries.
- Provide power from the electrical service to the toll locations
- Federal Communication Commission (FCC) License preparation and submission
- Provide complete testing, certification and acceptance of all systems for complete, fully operational TCS, furnished and installed.

The procurement, fabrication and installation of gantries for the TCS to be located on the segments of the Project will be by others. It is the responsibility of the SI, nevertheless, to work closely with CTRMA, TxDOT, and the various designers and roadway contractors to establish the precise locations for each of the gantry structures and to provide the Roadway Contractor(s) with detailed information of the installation for the TCS equipment at each location.

A5.0 Coordination and Project Interface

The SI is to participate in the process for coordination which will enable the contractors and designers of the SH 71 Toll Lanes Project to obtain specific, detailed information regarding the proposed TCS components in order to complete the design/construction of the appropriate toll facilities infrastructure. The SI will be responsible for maintaining relationships with a wide variety of third parties, including designers, roadway contractors, and various suppliers. In this role, the SI will work closely with CTRMA and TxDOT in developing the required network. The work related to this Work Authorization No. 12 generally will include, but not be limited to:

- Design input and providing detailed information including TCS component details, dimensions and layout configurations, and specific technical requirements for elements of the proposed TCS;
- Preparation of construction/installation guidelines for various components of CTRMA's TCS;
- Review of construction documents prepared by others;
- Attendance and participation at coordination meetings as determined by project schedule and/or as requested by the CTRMA. This includes attending design coordination meetings, construction meetings, and issue resolution meetings as necessary to resolve outstanding comments
- Provide "over the shoulder" reviews, as necessary
- Submit Installation Plan and Installation Drawings to the CTRMA for review and approval
- Provide input in the development of the project schedule as it relates to the installation and testing of the toll system. The SI shall review the project baseline schedule prepared by the D/B contractor for review and acceptance.

All TCS infrastructure facilities at the remote Toll Locations will be provided by others as indicated in *Section A6.0 and Section A7.0* hereof. The SI shall fully coordinate the designs for the TCS with others and provide the required details and technical requirements to ensure that the construction of the toll system infrastructure facilities will be fully compatible and meet the requirements for the CTRMA's TCS.

The SI is responsible for coordinating with others and for providing all necessary details, system requirements, and reviews of construction documents to ensure that the gantries are located and configured properly to accommodate the SI's own particular system components as required to meet the CTRMA TCS performance and accuracy requirements.

Prior to deploying any toll collection equipment or technology the SI shall certify to TxDOT that the technology complies with the interoperability rules that are in effect on the date of issuance of the request for proposals for the toll systems integration contract.

A6.0. Work by Others – Civil/Roadway Construction

The CTRMA, through its roadway construction contracts, will provide jointed concrete pavement in each of the areas designated for toll collection facilities. The pavement will be reinforced with Glass Fiber

Reinforced Polymer (GFRP) bars. Transverse joints and longitudinal joints will be placed at positions equal to lane widths and as shown on the CTRMA details. Power and communication lines to support the Wide Area Network (WAN) will be provided by others and terminated at an ILP enclosure in an area within 500 feet of ILP. The SI is responsible for the communication links between the Host, the CSC, the VPC, the future TMC, and all Remote Express Toll Location facilities via a Communication Trunkline and WAN.

Except as may be expressly indicated elsewhere, all toll system infrastructure required for the TCS at the designated remote Express Toll Locations will be provided and installed by others. The principle items of work and primary components of the TCS infrastructure at each remote Express Toll Location shall include, but are not limited to:

- GFRP Bar Reinforced Pavement Section;
- Retaining Walls and Coping Details;
- Drainage Features;
- Civil Site Work, including Grading, Access Driveways, and Fencing;
- All toll gantry procurement and installations, including foundations and gantry structures;
- ILP concrete foundation slab. The ILP's are to be provided with appropriate environmental protection and climate controls for housing the electronic equipment by the SI;
- Conduit and ground boxes providing connections between the ILP's and the ETC Lane equipment installations. NOTE: It is the responsibility of the SI to coordinate with the Roadway Contractor(s) for the placement and installation of these elements to ensure that the construction is acceptable for the TCS as designed;
- Gantry and ILP enclosure lightning protection air, terminal, Down Conductors, ILP Master Bus Bar, and Ground Electrodes. Equipment connection to the Ground Electrode for the ILP enclosure Master Ground Bus Bar will be provided by Others;
- Power and WAN communication services up to the location of the proposed ILP enclosures;
- Provide, install, and incorporate natural gas lines, if available. NOTE: SI is to coordinate and provide generator requirements including locations for gas feeds for the Emergency Generators;
- Concrete foundations for Emergency Generators and associated fuel tanks; and
- All signing, pavement markings, traffic barriers and other roadway appurtenances required at each remote Express Toll Location.

Refer to the Fixed Price Tolling Standards that were issued by the CTRMA on November 2013, which is included as *ATTACHMENT D*.

A7.0 Toll Facilities Responsibility Matrix

For this work authorization, the SI is responsible for design and coordination of the various aspects of the TCS as identified in *ATTACHMENT C - Toll Facilities and ITS Responsibility Matrix*, and shall work with the CTRMA, TxDOT, roadway designers and contractors, and others as described herein.

A8.0 Project Schedule

The Project Schedule shall be developed to incorporate the Milestone Dates established for this Work Authorization No. 12 as presented in *ATTACHMENT F*.
[END OF SECTION]

ATTACHMENT B

TOLL SYSTEM LAYOUT
State Highway 71 Toll Lanes

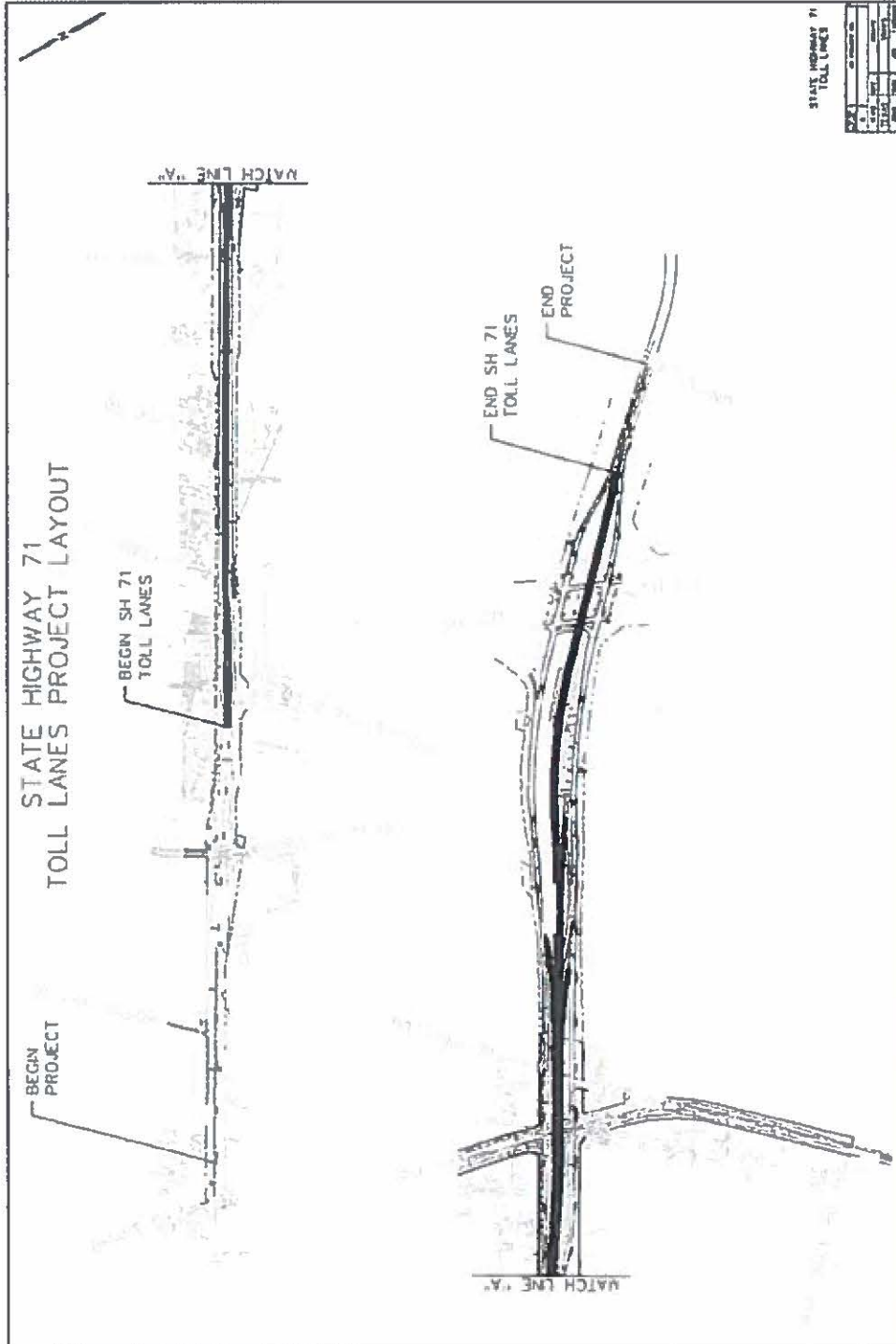

DRAFT

Toll System Implementation
Work Authorization No. 12

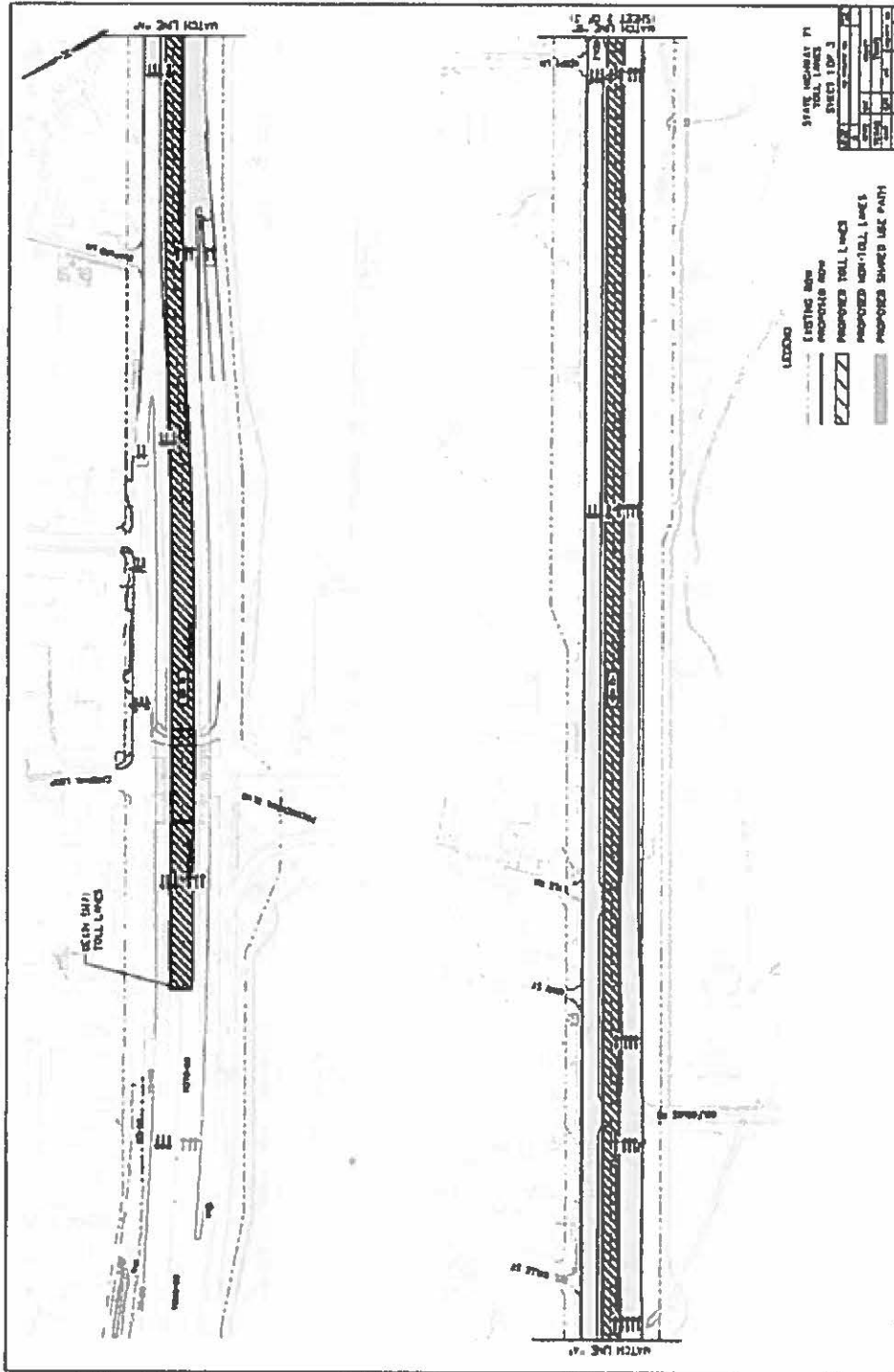

DRAFT

Toll System Implementation
Work Authorization No. 12

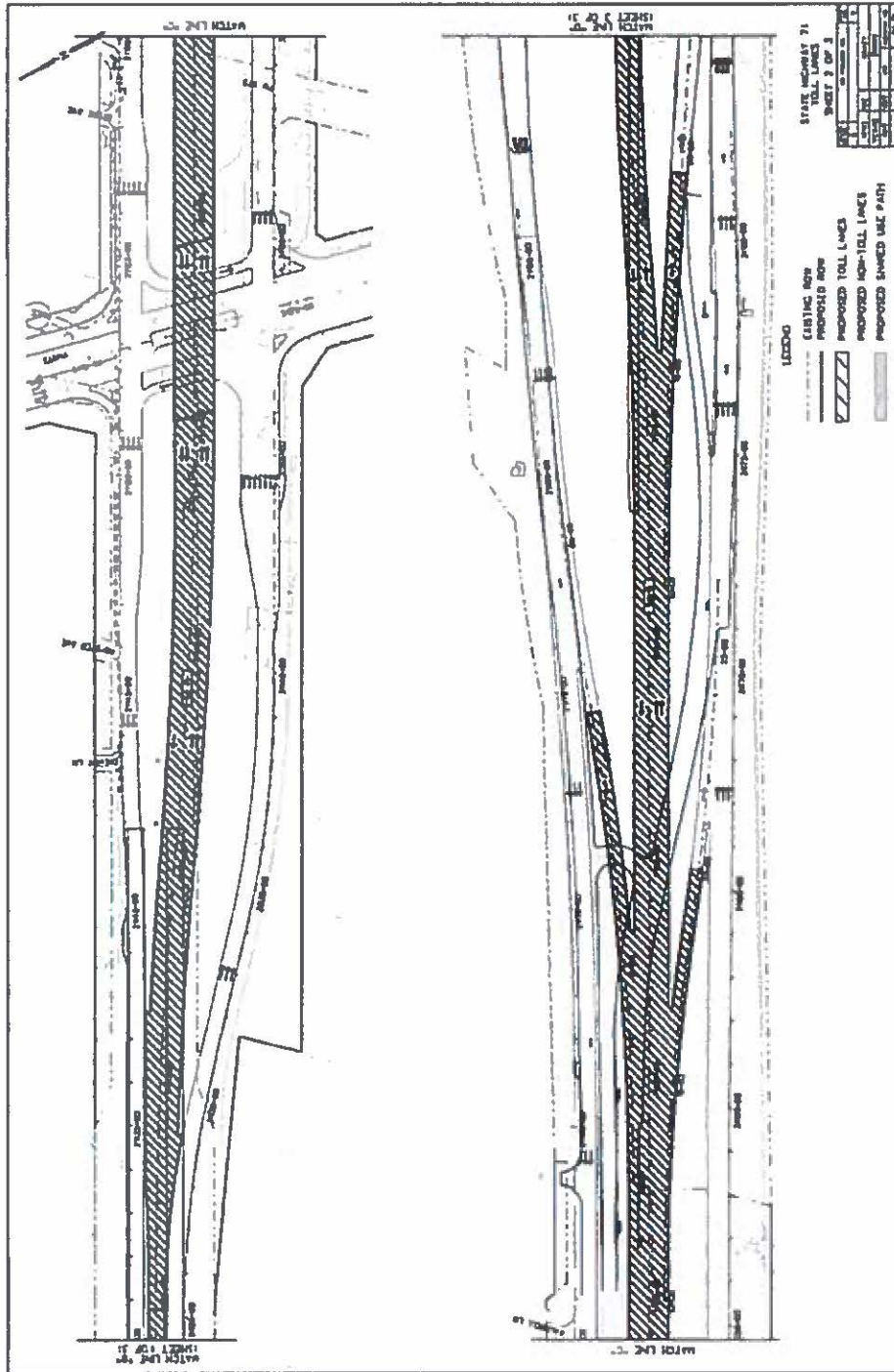

DRAFT

Toll System Implementation
Work Authorization No. 12

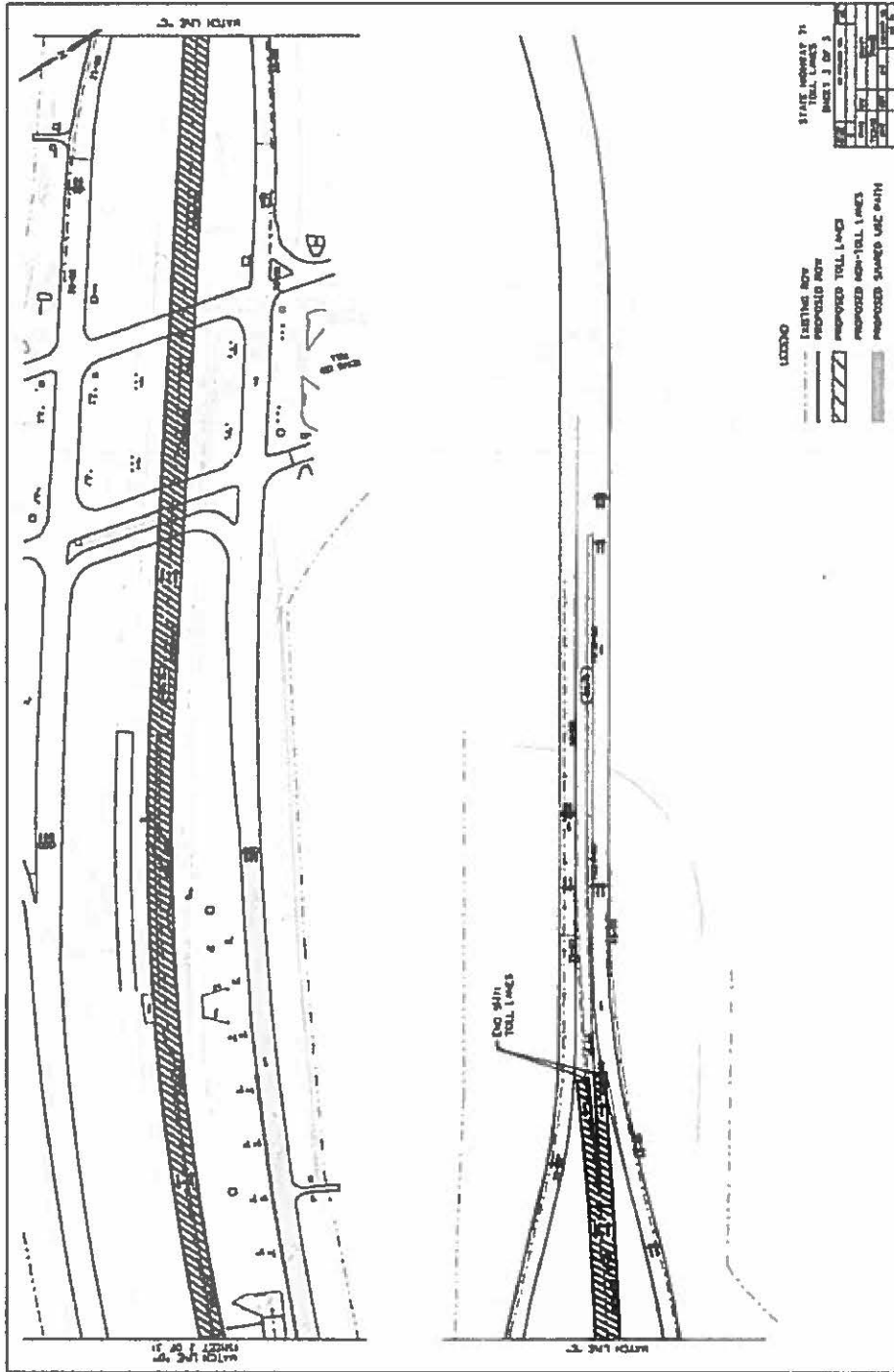

ATTACHMENT C
TOLL FACILITY RESPONSIBILITY MATRIX

DRAFT

Responsibility Assignment Legend							
Primary Responsibility: P	Support Responsibility: S		Coordination Responsibility Only: C			No Responsibility: N	
Element/Task/Component/ Sub-system	DB Contractor (DB)			Systems Integrator (SI)			Comments Other Responsibility/Information
	Design	Procure	Install/ Construct	Design	Procure	Install / Construct	
GENERAL REQUIREMENTS							
Schedule	P	P	P	S	C	S	DB must accommodate and incorporate the SI scheduled activities into the DB schedule. All schedule changes or updates which impact the SI tasks must be agreed to by the SI prior to submittal to the Mobility Authority. A weekly schedule must be distributed and incorporate any SI updates or changes.
Request for Early Opening	P	P	P	S	S	S	SI must be able to match schedule request for early opening to conform to requirements in RFDP.
Design Package – Installation and Electrical Design and Plans	P	P	P	C	N	C	DB to incorporate all SI requirements and specifications into Structural and Electrical Design Packages. SI to provide approval prior to issuance of Released For Construction (RFC) plans.
Grading	P	P	P	C	N	C	
Drainage	P	P	P	C	N	C	No culverts or pipes under tolling zones.
Utilities/Electrical Services	P	P	P	S	C	C	SI to provide specific power requirements for the Toll System. DB to incorporate into toll facilities design and construct power utilities interface, and all power infrastructure.
Traffic Control/Safe work zone	P	P	P	S	N	C	SI to provide DB detailed lane closure requirements and schedule for installation and testing.
Signing	P	P	P	C	N	N	All toll signing must be coordinated with and approved by the Mobility Authority. If toll price signs utilize changeable electronic signs, the DB will provide the static sign and the SI will provide the electronic insert.
Striping	P	P	P	S	N	C	SI to coordinate striping with pavement loop locations.
Lighting	P	P	P	S	C	S	Roadway and toll location lighting provided by DB. SI to provide lighting requirements in vicinity of toll locations and locations of other Toll System equipment. DB to confirm that lighting does not obstruct toll related signing or impede the Toll System.

**TOLL FACILITY RESPONSIBILITY MATRIX
SH 71 Project**

DRAFT

Responsibility Assignment Legend							
Primary Responsibility: P	Support Responsibility: S			Coordination Responsibility Only: C			No Responsibility: N
Element/Task/Component/ Sub-system	DB Contractor (DB)			Systems Integrator (SI)			Comments Other Responsibility/Information
	Design	Procure	Install/ Construct	Design	Procure	Install/ Construct	
Landscaping	P	P	P	C	N	N	
Fencing/Guardrail/Bollards/Concrete Barrier	P	P	P	S	C	C	SI to provide requirements for specific equipment clearances for Toll System. DB to incorporate into roadway design. SI to confirm that design plans meet requirements.
TOLL SYSTEM: LOCATIONS, LAYOUTS, STRUCTURES, MOUNTS/BRACKETS							
Locations and Layouts	P	P	P	S	C	C	SI to provide specific locations for the Toll System. SI to provide requirements for specific lane and facility layouts. DB to incorporate into Design Packages. SI to review and approve.
Gantries/Foundation/Trusses/Junction boxes/Conduits/Grounding	P	P	P	S	C	S	SI to provide requirements for conduits (for SI installed power and communications cables, including specific requirement for below ground conduits for the loops), junction boxes, and power needs for the Toll System. DB to incorporate into structural design, including electrical grounding, bonding. DB to provide and install junction boxes and conduit pull strings and bell ends for all conduits up to one foot above pole and gantry foundation. The DB will require SI to sign off on below-ground conduits for the loops prior to installation of special pavement structure.
Gantries/Foundation/Trusses/Junction boxes/Conduits/Grounding	S	C	S	P	P	P	SI to install conduits from one foot above grade to all Toll System components.
Equipment Mounts on Brackets/Frames	S	N	C	P	P	P	SI to procure and install all Toll System equipment, and related cable & wiring, including communications from roadside cabinets to the equipment mounted on the gantries. SI to provide requirements for all brackets and frames needed to attach SI procured equipment to DB provided truss.
Equipment Brackets/Frames on Gantries	P	P	P	S	N	C	DB to provide and install all frames needed to attach all SI procured equipment. SI to provide locations for installation to the DB. SI to provide and install all mounting brackets required for tolling equipment.

TOLL FACILITY RESPONSIBILITY MATRIX
SH 71 Project

DRAFT

Responsibility Assignment Legend							Comments Other Responsibility/Information
Primary Responsibility: P	Support Responsibility: S		Coordination Responsibility Only: C			No Responsibility: N	
Element/Task/Component/ Sub-system	DB Contractor (DB)			Systems Integrator (SI)			
	Design	Procure	Install/ Construct	Design	Procure	Install/ Construct	
Pavement structure, including special nonferrous zones and conduit stub-outs for in-pavement sensors/loops	P	P	P	S	N	C	SI to provide requirements for special pavement structure at toll gantry areas. SI shall coordinate joint spacing to avoid conflicts with loop placement and sign off on riser locations before concrete pour. DB to assure ferrous objects (i.e. rebar, grates, pipes, etc.) are not in toll revenue collection detection system(s) zone of influence. DB to locate loop risers after pavement is poured.
EQUIPMENT CABINETS							
Toll Equipment Cabinets	C	N	S	P	P	P	SI to provide size and number of cabinets needed for Toll System. DB shall incorporate location into site grading and drainage. SI to procure and install environmentally controlled cabinets. The environmentally controlled enclosures provided by SI must comply with the America Society of Heating, Refrigeration, and Air Conditioning Engineers Thermal Guidelines for Data Processing Environments. DB to provide traffic control devices and safe working conditions for SI during installation of all toll equipment.
Toll Equipment Cabinet Site (TEC) and Roadside Equipment Cabinet Base Slabs	P	P	P	S	N	C	SI to provide requirements for specific equipment weight and anchorages for cabinets to the DB. DB to incorporate into Roadway Design. DB to install slabs with conduit plumbing.
Facility Security and Security Communications at Toll System locations	C	N	C	P	P	P	SI to provide security communications for all toll system equipment. DB to incorporate into the Roadway Design.
TOLL SUB-SYSTEMS							
Automatic Vehicle Identification (AVI) Antennas and Readers	N	N	S	P	P	P	SI to provide AVI System Mounts, Wiring and Cables. SI will perform all AVI system installation and terminations, and to make the connections to the electronics in the cabinets.
Automatic Vehicle Classification and Detection (AVC) and (AVD)	N	N	S	P	P	P	SI to install, connect and terminate AVC and/or AVD System mounted on the gantries and/or

**TOLL FACILITY RESPONSIBILITY MATRIX
SH 71 Project**

DRAFT

Responsibility Assignment Legend							
Primary Responsibility: P	Support Responsibility: S			Coordination Responsibility Only: C			No Responsibility: N
Element/Task/Component/ Sub-system	DB Contractor (DB)			Systems Integrator (SI)			Comments Other Responsibility/Information
	Design	Procure	Install/ Construct	Design	Procure	Install / Construct	
In-Pavement Sensors/Loops	N	N	S	P	P	P	installed in the pavement to the electronics in the cabinets. SI to saw cut pavement, procure, install, and seal pavement sensors with approved sealant. DB to assure ferrous objects (i.e. rebar, grates, etc.) are not in toll revenue collection detection system(s) zone of influence.
Video Capture Sub-System (VCS/VES) Cameras, Illumination, Sensors and Servers	N	N	S	P	P	P	SI to provide, install, terminate all Video Capture Sub-System (VCS/VES) equipment.
In-Lane Processing Servers and Electronics	N	N	N	P	P	P	SI to provide, install, connect, and terminate all electronics in the cabinet and assures proper communications to the devices on the gantry and/or in the pavement.
POWER DISTRIBUTION SUB-SYSTEM							
Metered power service at each location:	P	P	P	C	N	C	SI to provide power requirements and special requirements for construction of utilities near each Toll System. DB to provide and install necessary conduit & junction/pull boxes.
Metered power service at each toll location:	C	N	C	P	P	P	The SI shall provide and install all other wiring, switches, surge protection/suppression, etc. for power from the meter for the Toll System equipment. SI will terminate all power wiring from ATS at Toll System.
Generators & Automatic Transfer Switches (ATS)	S	N	C	P	P	P	SI to provide generators, ATS, generator cabinets, wiring, connect and terminate all power at the Toll System sites.
Generator Power Source is Natural Gas (if applicable)	P	P	P	S	N	C	If natural gas is available, the DB shall provide, install and incorporate the gas lines into the roadway design. SI to coordinate and provide generator requirements including location for gas feed.
Generator Power Source is propane or diesel	S	N	C	P	P	P	The SI shall provide, and install the propane/diesel tank for the generator if natural gas is not a viable option for the project. The Mobility Authority will

TOLL FACILITY RESPONSIBILITY MATRIX
SH 71 Project

DRAFT

Responsibility Assignment Legend							
Primary Responsibility: P	Support Responsibility: S		Coordination Responsibility Only: C			No Responsibility: N	
Element/Task/Component/ Sub-system	DB Contractor (DB)			Systems Integrator (SI)			Comments Other Responsibility/Information
	Design	Procure	Install/ Construct	Design	Procure	Install/ Construct	
							decide if propane or diesel will be used.
Uninterruptible Power Supplies (UPS)	S	N	C	P	P	P	SI to provide and install Uninterruptible Power Supply Systems (UPS) in the cabinets. UPS will be required for the Toll System.
Lightning Protection & Grounding	P	P	P	S	C	C	SI to provide specific requirements for equipment lightning protection and grounding. DB to furnish and install required lightning protection and grounding.
COMMUNICATIONS SUB-SYSTEMS							
Conduits/Ducts & Junction/Pull Boxes/Outlets	P	P	P	S	C	S	SI to provide specific Communications design requirements including location of long-radius sweep conduit bends. DB to incorporate into the roadway design and install including conduits, junction boxes, bell ends with pull strings. The DB Contractor shall verify that all duct banks and conduits are clear and have pull strings prior to the beginning of the Toll System installation.
Fiber Optic cabling in conduits for Toll System	S	S	S	P	P	P	SI to provide fiber requirements for Toll System. DB to incorporate into design of backbone and laterals. SI to furnish and install along the corridor from communication hub to cabinets.
Toll Hardware in Cabinets	C	N	C	P	P	P	SI to provide and install all toll hardware within the cabinets. Equipment must be installed in a clean and organized manner and must not be affected by the environmental controls. The SI must provide and install the redundant environmental controls.
Routers	C	N	C	P	P	P	SI to provide, install and configure the routers for connection from hub locations to the Mobility Authority's Traffic Management Center (TMC).
Hubs	N	N	C	P	P	P	If applicable.
Switches	N	N	C	P	P	P	SI to provide, install and configure the switches for connection from tolling to hub locations.
Firewalls	N	N	C	P	P	P	SI to provide, install and configure the necessary firewall for the toll system.
Patch/Distribution Panels	N	N	C	P	P	P	SI to provide and install all the necessary patch and distribution panels to provide Fault Tolerant Single

**TOLL FACILITY RESPONSIBILITY MATRIX
SH 71 Project**

DRAFT

Responsibility Assignment Legend							
Primary Responsibility: P	Support Responsibility: S		Coordination Responsibility Only: C			No Responsibility: N	
Element/Task/Component/ Sub-system	DB Contractor (DB)			Systems Integrator (SI)			Comments Other Responsibility/Information
	Design	Procure	Install/ Construct	Design	Procure	Install / Construct	
Corridor Communications System	S	N	C	P	P	P	Mode Fiber Optic IP-Based Communication System. SI to provide Fault Tolerant Single Mode Fiber Optic IP-Based Communication System for Toll Revenue Collection Systems
Corridor Communications Conduits	P	P	P	C	N	S	DB to provide branch conduit to the TxDOT ductbank system, including conduit, ground boxes, and terminations
Corridor to Traffic Management Center (TMC)	N	N	N	P	P	P	SI to provide Fault Tolerant IP-Based Communication System to the TMC for Toll Revenue Collection Systems.
Data/Communications Service to each Tolling Location	N	N	N	P	P	P	SI to provide system design plans indicating power and communications/data requirements. SI to install up to the Toll System locations at demark panel.
SYSTEMS SERVERS AND SPACE							
Toll Collection Systems Computer(s)	N	N	N	P	P	P	
Support Equipment at CTRMA Offices	N	N	N	P	P	P	SI to provide data and power wiring schematics, equipment rack/cabinet requirement, and elevations, layouts, floor plans, air flow diagrams, and environmental controls load calculations, electrical power distribution, including grounding, bonding, lightning protection, panel boards, TVSS, circuit breakers conduit, conductors, j-boxes, receptacles.
Systems Servers & Workstations	N	N	C	P	P	P	SI to provide, install and configure all system servers and workstations required at the TMC to support the operations and management of the Project.

TOLL FACILITY RESPONSIBILITY MATRIX
SH 71 Project

DRAFT

Responsibility Assignment Legend							
Primary Responsibility: P	Support Responsibility: S		Coordination Responsibility Only: C			No Responsibility: N	
Element/Task/Component/ Sub-system	DB Contractor (DB)			Systems Integrator (SI)			Comments Other Responsibility/Information
	Design	Procure	Install/ Construct	Design	Procure	Install / Construct	
Federal Communication Commission License Preparation and Submission	C	N	N	P	P	P	SI to provide all information necessary to acquire FCC Licensing to the Mobility Authority.
DUCT BANK & INTELLIGENT TRANSPORTATION SYSTEMS (ITS) – TXDOT OWNED							
Duct Bank Adjustment & ITS relocations design	P	P	P	N	N	N	DB is responsible for the design of any necessary ITS relocations, including, foundations, conduits, electrical services, grounding circuits, and support structures. DB responsible for adjusting any existing duct bank manholes and providing new junction boxes and manholes if in conflict with the project. Coordination with TxDOT will be required.
Duct Bank Adjustments/new connections	P	P	P	S	N	C	DB is responsible for all manhole adjustments and new manhole ties.
Fiber optic cables	P	P	P	N	N	N	Any adjustments to existing cables are DB responsibility.
Relocation of existing CCTV & DMS foundations, conduits, grounding, camera poles, and electrical services	P	P	P	N	N	N	DB is responsible for relocating any existing CCTV and DMS structures and services impacted by the Project Design, including communications and power. Damaged or inoperable equipment shall be moved but not repaired.
Existing and new vehicle detector foundations, conduits, loops, grounding, vehicle detector support structures, and electrical services	P	P	P	N	N	N	DB to coordinate with TxDOT regarding any existing vehicle detector/ loops within the pavement to determine if they need to be replaced/ relocated. The DB will replace/relocate any detectors/loops unless TxDOT prefers to do the work. Any damaged detectors/loops that are to remain must be replaced by the DB.
Vehicle detectors, communications, and equipment enclosures	P	P	P	N	N	N	

DRAFT



**CENTRAL TEXAS
Regional Mobility Authority**

**FIXED PRICE TOLLING STANDARDS
2 - 4 LANES**

ISSUED: NOVEMBER 2013

**ATTACHMENT D
FIXED PRICE TOLLING STANDARDS**

DRAFT

Project: 1111
 Date: 11/15/11
 Location: I-35 Corridor, Dallas, TX
 Drawing: INDEX OF SHEETS
 Scale: 1" = 1'-0"
 Author: J. Smith
 Checker: M. Jones
 Approver: D. Brown
 Date: 11/15/11
 Project: 1111
 Date: 11/15/11
 Location: I-35 Corridor, Dallas, TX
 Drawing: INDEX OF SHEETS
 Scale: 1" = 1'-0"
 Author: J. Smith
 Checker: M. Jones
 Approver: D. Brown
 Date: 11/15/11

CENTRAL TEXAS REGIONAL MOBILITY AUTHORITY NOVEMBER 2013 ALL RIGHTS RESERVED

STANDARD PLANS & GUIDELINES

INDEX OF SHEETS

3	GN-1	GENERAL NOTES
4	ABB-1	ABBREVIATIONS
5	S-1	SYMBOLS USED
6	TC-1	TERMS AND CONDITIONS
7	ETC-1	EXAMPLE ETC CONFIGURATION
8	ETC-2	EXAMPLE ETC CONFIGURATION
9	ETC-3	EXAMPLE ETC CONFIGURATION
10	TES-1	TOLL EQUIPMENT SITE PLACEMENT DETAILS
11	P1-ML	MAIN LANE PAVEMENT JOINTING PLAN AND GROUND BOX LAYOUT
12	P1-RMP	RAMP PAVEMENT JOINTING PLAN AND GROUND BOX LAYOUT
13	P2-ML	GROUND BOX PLACEMENT AND CONDUIT RISER LOCATION (MAIN LANES)
14	P2-RMP	GROUND BOX PLACEMENT AND CONDUIT RISER LOCATION (RAMPS)
15	G1-ML	MAIN LANE GANTRY CROSS-LANE TANGENT ELEVATION VIEW
16	G2-RMP	RAMP GANTRY CROSS-LANE TANGENT ELEVATION VIEW
17	MC-1	TOLL GANTRY MISCELLANEOUS DETAILS
18	LP-1	LIGHTNING PROTECTION SYSTEM DETAILS
19	A1-A4	CONDUIT RISER DETAILS
20	DETAIL E1	TOLL GANTRY ELECTRICAL SINGLE-LINE DRAWING
21	DR-1	DRIVERWAY DETAIL
22	TAJ-1	TERMINAL ANCHOR JOINT - JOINTED
23	CATD-1	CONCRETE TO ASPHALT TRANSITION DETAIL
24	JC-1	JOINTED CONCRETE PAVEMENT

INTERIM REVIEW ONLY
 Document prepared and intended for
 general circulation
 Engineer: J. Smith
 P.E. License No.: 91123
 Date: 11/15/11

HNTB 4410 Lexington
 The Woodlands, Texas 77380
 Toll Free: 800.368.5878

CENTRAL TEXAS
 Regional Mobility Authority

FIXED PRICE TOLLING STANDARDS INDEX OF SHEETS

Sheet No.	1111-01	Project No.	1111-01
Scale	1" = 1'-0"	Revision	0
Author	J. Smith	Checked	M. Jones
Drawn	J. Smith	Approved	D. Brown
Date	11/15/11	Project	1111

DRAFT

This document is the property of HNTB Corporation. It is to be used only for the project and location specified herein. It is not to be distributed, copied, or used for any other project or location without the written consent of HNTB Corporation.

GENERAL NOTES

- 1. REFERENCE SHEET: THE SYSTEM INTEGRATOR SHALL PROVIDE A SUMMARY STATION AND OFFSET TABLE FOR ALL OF THE FOLLOWING FOR EACH GANTRY LOCATION:
 - AVDS & AVC ENTRY, MIDDLE, EXIT, AND AXLE CONDUIT RISERS (IF NECESSARY)
 - AVDS & AVC ENTRY, MIDDLE, EXIT, AND AXLE LOOPS (IF NECESSARY)

- 2. REFERENCE SHEET: THE DESIGN BUILDER SHALL PROVIDE A SUMMARY STATION AND OFFSET TABLE FOR ALL OF THE FOLLOWING FOR EACH GANTRY LOCATION:
 - GANTRY COLUMNS & TRUSSES
 - PAYEMENT SECTION JOINTS (JOINTS SHALL BE DESIGNED SO THAT NO LOOP CROSSES ANY JOINT)

- 3. TXDOT ELECTRICAL DETAIL SHEETS SHALL APPLY.
- 4. NATIONAL ELECTRIC CODE (NEC), NFPA 780, NESC REQUIREMENTS SHALL APPLY.
- 5. TXDOT ITEM 618 SHALL GOVERN FOR ALL CONDUIT REQUIREMENTS.
- 6. TXDOT ITEM 620 SHALL GOVERN FOR ALL ELECTRICAL CONDUCTION REQUIREMENTS.
- 7. TXDOT ITEM 624 SHALL GOVERN FOR ALL GROUND BOXES. HS 20 LOAD RATING REQUIREMENTS SHALL GOVERN IN ALL LOCATIONS SUBJECT TO TRAFFIC LOADING.
- 8. TXDOT ITEM 628 SHALL GOVERN FOR ALL ELECTRICAL SERVICES. THE DESIGN BUILDER SHALL CONTACT RESPECTIVE UTILITY FOR LOCATION OF ELECTRICAL SERVICE.
- 9. SITE CONDITIONS MAY REQUIRE MODIFICATION TO THE JCP TO EXISTING PAYEMENT TRANSITION.
- 10. DETAILS ARE SUBJECT TO REVISIONS PERIODICALLY AS REQUIRED BY SYSTEM INTEGRATOR TECHNOLOGIES.

INTERIM REVIEW ONLY
 Issued for informational use only. Not for construction.
 Revision: 01/17/17 - 01/17/17
 P. E. Seal No. 24733
 Date: 01-10-17

HNTB HNTB Corporation
 700 W. 10th Street
 Oklahoma City, Oklahoma 73102
 Phone: 405.453.7000

 REGIONAL MOBILITY AUTHORITY

FIXED PRICE TOLLING STANDARDS GENERAL NOTES

REV			
NO.	DATE	DESCRIPTION	BY

DRAFT

File Path: H:\2015\1501\1501.dwg Plot Date: 11/11/2015 11:11:11 AM Plotter: HP DesignJet T1100e
 Plot File Path: H:\2015\1501\1501.dwg Plot Date: 11/11/2015 11:11:11 AM Plotter: HP DesignJet T1100e

- | | | | |
|----------------------------------|----------|--------------------------------|----------|
| GROUND/PULL BOX | [Symbol] | CONDUIT | [Symbol] |
| GENERATOR | [Symbol] | PROPANE TANK (250 GALLON TANK) | [Symbol] |
| COMMUNICATIONS | [Symbol] | ENCASED CONDUIT | [Symbol] |
| ELECTRICAL SERVICE | [Symbol] | BLACK VINYL FENCE | [Symbol] |
| SUPPORTING COLUMN | [Symbol] | (8' TALL) | [Symbol] |
| JUNCTION BOX | [Symbol] | TOLL ELECTRONICS CABINET | [Symbol] |
| DISCONNECT SWITCH | [Symbol] | | |
| AUTOMATIC TRANSFER SWITCH (ATS) | [Symbol] | | |
| AUTO VEHICLE CLASSIFICATION LOOP | [Symbol] | | |
| AUTO VEHICLE DETECTION LOOP | [Symbol] | | |

INTERIM REVIEW ONLY
 Approved for construction per the
 provisions of the contract documents.
 Date: 11/11/2015
 By: [Signature]



4010 Sand Springs
 Houston, Texas 77054
 Telephone: 713.243.8800
 Fax: 713.243.8801



CENTRAL TEXAS
 Regional Authority

**FIXED PRICE
 TOLLING STANDARDS
 SYMBOLS USED**

1	
DATE: 11/11/2015	PROJECT: 1501
DRAWN BY: [Name]	CHECKED BY: [Name]
TITLE: [Text]	SCALE: [Text]
1	

DRAFT

TERMS & CONDITIONS

THE CENTRAL TEXAS REGIONAL MOBILITY AUTHORITY (HEREINAFTER REFERRED TO AS MOBILITY AUTHORITY) IS COMMITTED TO PROVIDING ELECTRONIC ACCESS TO FILES OF STANDARDS. MOBILITY AUTHORITY MAKES EVERY REASONABLE EFFORT TO DO SO IN A CROSS PLATFORM AND COMPLEX MULTI PROTOCOL ENVIRONMENT. MOBILITY AUTHORITY DOES NOT POSSESS A STAFF THAT IS AVAILABLE TO PROVIDE TECHNICAL SUPPORT TO OUTSIDE PARTIES WHO AVAIL THEMSELVES OF CAD FILES THAT ARE PROVIDED. IT IS IMPORTANT, THEREFORE, THAT ALL POTENTIAL USERS OF THESE FILES READ THE FOLLOWING DISCLAIMER AND ACCEPT ITS TERMS AS A PREREQUISITE TO THE USE OF THE FILES.

IF THE RECEIVER PROCEEDS, THE RECEIVER AGREES TO THE FOLLOWING TERMS AND CONDITIONS:

1. MOBILITY AUTHORITY MAKES NO WARRANTY OF ANY KIND, EXPRESS OR IMPLIED, WITH RESPECT TO THE FILE(S) WHICH ARE THE SUBJECT OF THIS AGREEMENT, AND SPECIFICALLY MAKES NO WARRANTY THAT SAID FILE(S) SHALL BE MARKETABLE OR FIT FOR ANY PARTICULAR PURPOSE. FURTHERMORE, ANY DESCRIPTION OF SAID FILE(S) SHALL NOT BE DEEMED TO CREATE AN EXPRESS WARRANTY THAT SUCH FILES SHALL CONFORM TO SAID DESCRIPTION.
2. RECEIVER ASSUMES ALL RISK AND LIABILITY FOR ANY LOSSES, DAMAGES, CLAIMS OR EXPENSES RESULTING FROM THE USE OR POSSESSION OF ANY FILE(S) FURNISHED BY MOBILITY AUTHORITY PURSUANT TO THIS AGREEMENT.
3. RECEIVER AGREES TO INDEMNIFY, DEFEND AND HOLD HARMLESS MOBILITY AUTHORITY, ITS OFFICERS, AGENTS, AND EMPLOYEES FROM AND AGAINST ANY AND ALL CLAIMS, SUITS, LOSSES, DAMAGES OR COSTS, INCLUDING REASONABLE ATTORNEY'S FEES, ARISING FROM OR BY REASON OF RECEIVER(S) USE OR POSSESSION WITH RESPECT TO ANY OF THE FILE(S) FURNISHED BY MOBILITY AUTHORITY PURSUANT TO THIS AGREEMENT, AND SUCH INDEMNIFICATION SHALL SURVIVE ACCEPTANCE OF SAID FILE(S) BY RECEIVER.
4. ALL DESIGN FILE STANDARDS ARE AVAILABLE IN MICROSTATION DRAWING FILES (*.DGN). RECEIVER AGREES THAT MOBILITY AUTHORITY CANNOT BE HELD RESPONSIBLE FOR PROBLEMS ARISING FROM FILES WHICH HAVE BEEN CONVERTED FOR USE IN NON NATIVE APPLICATIONS (E.G. MICROSTATION DESIGN FILES TO AUTOCAD).
5. MICROSTATION (*.DGN) FILENAMES THAT HAVE A COMPANION PDF ICON CAN BE VIEWED IN ADOBE ACROBAT READER BY CLICKING ON THE PDF ICON. THIS READER CAN BE USED TO PRINT THESE PDF FILES. RECEIVER AGREES THAT MOBILITY AUTHORITY ASSUMES NO RESPONSIBILITIES FOR PRINTING WITH ADOBE. ALSO, RECEIVER AGREES THAT MOBILITY AUTHORITY CANNOT BE HELD RESPONSIBLE FOR ANY PROBLEMS ARISING WITH THE PRINTING OF A PDF FILE.
6. RECEIVER AGREES THAT MOBILITY AUTHORITY CANNOT PROVIDE THE FILES IN OTHER FILE FORMATS OR COMPRESSED FORMATS, AND AGREES TO ACCEPT THE FILES IN THE FORMAT PROVIDED.
7. SINCE REVISIONS OR ADDITIONS TO THE DESIGN FILE STANDARDS MAY OCCUR AT ANY TIME, THE RECEIVER AGREES TO INDEMNIFY, DEFEND AND HOLD HARMLESS MOBILITY AUTHORITY, ITS OFFICERS, AGENTS, EMPLOYEES, AND CONSULTANTS FROM AND AGAINST ANY AND ALL CLAIMS, SUITS, LOSSES, DAMAGES OR COSTS, INCLUDING REASONABLE ATTORNEY'S FEES, ARISING FROM THE USE OF OUTDATED DESIGN FILE STANDARDS. SUCH INDEMNIFICATION SHALL SURVIVE ACCEPTANCE OF SAID FILE(S) BY RECEIVER.
8. THE DESIGN FILES STANDARDS ARE COPYRIGHTED BY MOBILITY AUTHORITY AND MAY NOT BE RESOLD.
9. THESE TERMS AND CONDITIONS CONSTITUTE THE COMPLETE AND FINAL AGREEMENT OF THE PARTIES HERETO. RECEIVER ACCEPTS THE AFOREMENTIONED TERMS AND CONDITIONS.

INTERIM REVIEW ONLY
 Standard description not intended for
 permit, bidding or administration
 Engineer: **DEB S. ELLEN**
 I. Number: **3112**
 Date: **12/02/2011**

HNTB HNTB Corporation
 14000 North Loop West
 Houston, Texas 77040
 281.444.4400

(EST. 1948)
Regional Mobility Authority

**FIXED PRICE
 TOLLING STANDARDS
 TERMS AND
 CONDITIONS**

DESIGNED BY:	DATE:	REVISED BY:	DATE:	APPROVED BY:

Files for use in the design of the project are provided to the user as a courtesy of the Regional Mobility Authority. The user is responsible for the use of these files. The user is not to be held responsible for any damage or loss of data resulting from the use of these files. The user is not to be held responsible for any damage or loss of data resulting from the use of these files.

DRAFT

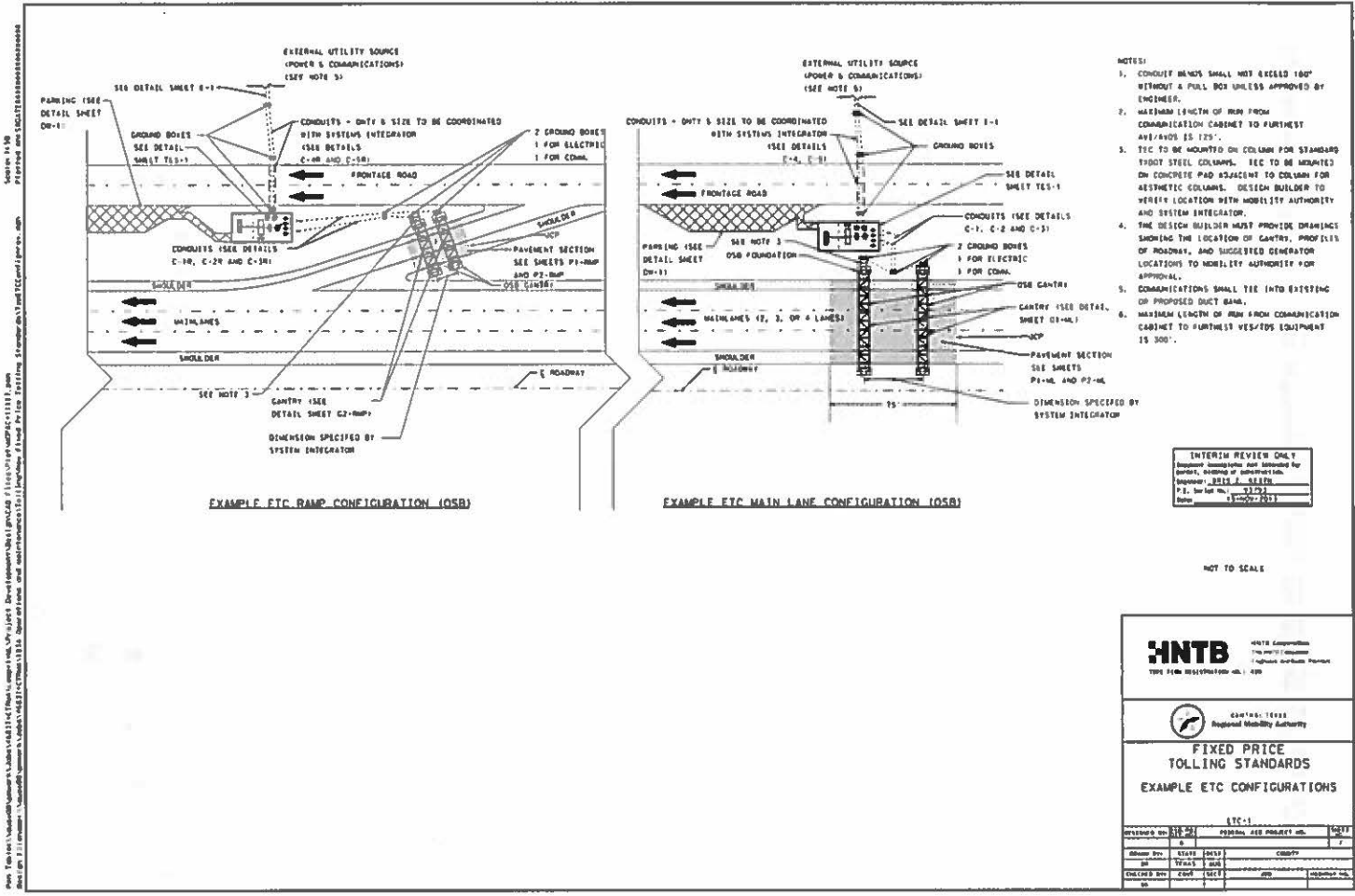

- NOTES:
1. CONDUIT BUNDLES SHALL NOT EXCEED 180" WITHOUT A PULL BOX UNLESS APPROVED BY ENGINEER.
 2. MAXIMUM LENGTH OF RUN FROM COMMUNICATION CABINET TO FURTHEST ANTENNA IS 125'.
 3. TIC TO BE MOUNTED ON COLUMN FOR STANDARD TYPED STEEL COLUMNS. TIC TO BE MOUNTED ON CONCRETE PAD ADJACENT TO COLUMN FOR AESTHETIC COLUMNS. DESIGN BUILDER TO VERIFY LOCATION WITH MOBILITY AUTHORITY AND SYSTEM INTEGRATOR.
 4. THE DESIGN BUILDER MUST PROVIDE DRAWINGS SHOWING THE LOCATION OF CANTRY, PROFILES OF ROADWAY, AND SUGGESTED GENERATOR LOCATIONS TO MOBILITY AUTHORITY FOR APPROVAL.
 5. COMMUNICATIONS SHALL TIE INTO EXISTING OR PROPOSED DUCT BANK.
 6. MAXIMUM LENGTH OF RUN FROM COMMUNICATION CABINET TO FURTHEST VES/IDS EQUIPMENT IS 300'.

INTERIM REVIEW ONLY
 Approved drawings not intended for
 permit, bidding or construction.
 Approved: 2014.7.23.12
 P.L. for file no. 2122
 Date: 7/23/14

NOT TO SCALE



CENTRAL TEXAS
 Regional Mobility Authority

**FIXED PRICE
 TOLLING STANDARDS
 EXAMPLE ETC CONFIGURATIONS**

REVISED BY	DATE	DESCRIPTION	BY
0			
DESIGNED BY	DATE	BY	APP
0			

DRAFT

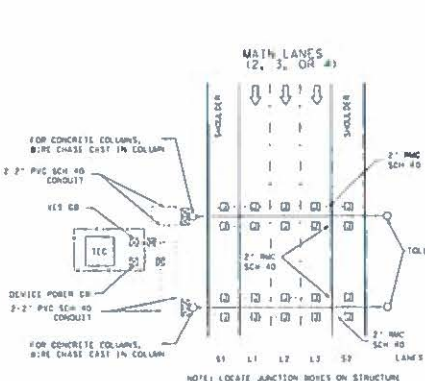
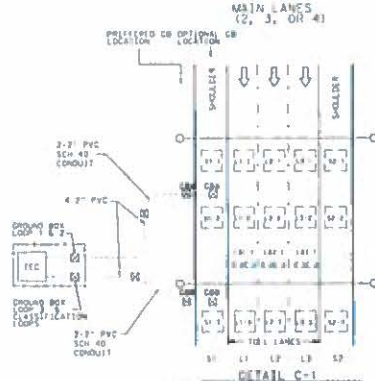

- NOTES:
- 1) BOXES SHALL BE PLACED AS SHOWN IN PLANS OR AS DIRECTED BY THE ENGINEER.
 - 2) RETAINING WALL SECTIONS SHALL REQUIRE 4" SCH 80 PVC CONDUITS FROM ROADWAY SHOULDER FACE BOX TO A PULL BOX LOCATED ON THE GROUND BY FACE OF RETAINING WALL.
 - 3) DETAIL C1 MINIMUM CABLE LENGTH FROM S1-1 AND S1-3 TO TEC SHALL NOT EXCEED 100'.
 - 4) TEC TO BE MOUNTED ON COLUMN OR STANDARD TOWER STEEL COLUMN. TEC TO BE MOUNTED ON CONCRETE PIG ADJACENT TO COLUMN FOR AESTHETIC COLUMN. DESIGN BUILDER TO VERIFY LOCATION WITH MOBILITY AUTHORITY AND SYSTEM INTEGRATOR.
 - 5) FOR DETAILS OF TOLL COLLECTION SYSTEM CONFIGURATION, COORDINATE WITH SYSTEM INTEGRATOR.
 - 6) GROUND BOXES LOCATED IN PAVEMENT SHALL BE PRECAST CONCRETE VS 20 LINED WITH REMOVABLE BOLTED COVER, NO REMOVABLE MATERIAL ALLOWED FOR GROUND BOXES.
 - 7) PROVIDE A MINIMUM OF 2" CLEARANCE BETWEEN TOP OF GROUND AND/OR CONCRETE AND BOTTOM OF PAVEMENT AND/OR CONCRETE STRUCTURE.
 - 8) SYSTEM INTEGRATOR OR MOBILITY AUTHORITY MUST APPROVE OF ALL DESIGN DRAWINGS.
 - 9) WIRES RUNNING IN COLUMNS SHALL EITHER BE IN THE COLUMN IN RECESSED CHASE OR IN CONDUIT FOR TRUSS COLUMNS.
 - 10) ALL GROUND/PULL BOX SIZES AND MODELS MUST BE APPROVED BY THE MOBILITY AUTHORITY OR SYSTEM INTEGRATOR.
 - 11) FOR 2 MAIN LANES, REMOVE L2 FOR 4 MAIN LANES, REMOVE L2 AND L3.

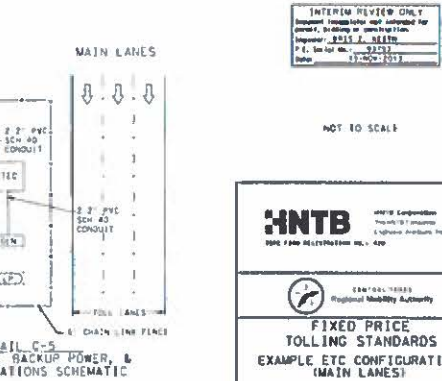
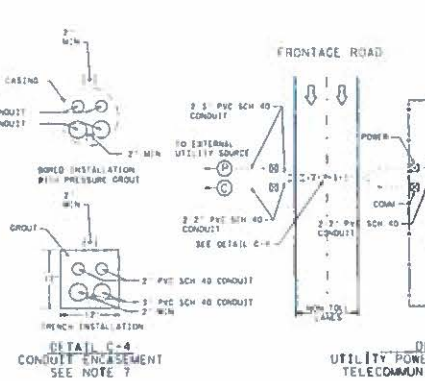
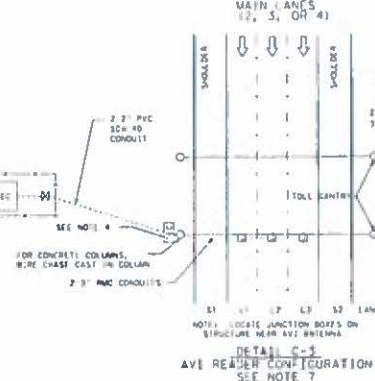

INTERIM REVIEW ONLY
 Request location for and submitted for
 permit, building or construction
 engineer: **JOHN A. WELLS**
 P.E. License No. 33233
 Date: 07/06/2017

NOT TO SCALE

HNTB HNTB Corporation
 10000 North Central Expressway
 Dallas, Texas 75265
 Telephone: 972.962.8000
 Fax: 972.962.8001
 www.hntb.com

CONTRACT NO. **15010001**
 REGIONAL MOBILITY AUTHORITY

FIXED PRICE TOLLING STANDARDS EXAMPLE ETC CONFIGURATION (MAIN LANES)

ETC-1		ETC-2	
SECTION NO.	SECTION DESCRIPTION	SECTION NO.	SECTION DESCRIPTION
1	ETC-1	2	ETC-2
2	ETC-1	3	ETC-2
3	ETC-1	4	ETC-2
4	ETC-1	5	ETC-2
5	ETC-1	6	ETC-2
6	ETC-1	7	ETC-2
7	ETC-1	8	ETC-2
8	ETC-1	9	ETC-2
9	ETC-1	10	ETC-2
10	ETC-1	11	ETC-2
11	ETC-1	12	ETC-2
12	ETC-1	13	ETC-2
13	ETC-1	14	ETC-2
14	ETC-1	15	ETC-2
15	ETC-1	16	ETC-2
16	ETC-1	17	ETC-2
17	ETC-1	18	ETC-2
18	ETC-1	19	ETC-2
19	ETC-1	20	ETC-2
20	ETC-1	21	ETC-2
21	ETC-1	22	ETC-2
22	ETC-1	23	ETC-2
23	ETC-1	24	ETC-2
24	ETC-1	25	ETC-2
25	ETC-1	26	ETC-2
26	ETC-1	27	ETC-2
27	ETC-1	28	ETC-2
28	ETC-1	29	ETC-2
29	ETC-1	30	ETC-2
30	ETC-1	31	ETC-2
31	ETC-1	32	ETC-2
32	ETC-1	33	ETC-2
33	ETC-1	34	ETC-2
34	ETC-1	35	ETC-2
35	ETC-1	36	ETC-2
36	ETC-1	37	ETC-2
37	ETC-1	38	ETC-2
38	ETC-1	39	ETC-2
39	ETC-1	40	ETC-2
40	ETC-1	41	ETC-2
41	ETC-1	42	ETC-2
42	ETC-1	43	ETC-2
43	ETC-1	44	ETC-2
44	ETC-1	45	ETC-2
45	ETC-1	46	ETC-2
46	ETC-1	47	ETC-2
47	ETC-1	48	ETC-2
48	ETC-1	49	ETC-2
49	ETC-1	50	ETC-2
50	ETC-1	51	ETC-2
51	ETC-1	52	ETC-2
52	ETC-1	53	ETC-2
53	ETC-1	54	ETC-2
54	ETC-1	55	ETC-2
55	ETC-1	56	ETC-2
56	ETC-1	57	ETC-2
57	ETC-1	58	ETC-2
58	ETC-1	59	ETC-2
59	ETC-1	60	ETC-2
60	ETC-1	61	ETC-2
61	ETC-1	62	ETC-2
62	ETC-1	63	ETC-2
63	ETC-1	64	ETC-2
64	ETC-1	65	ETC-2
65	ETC-1	66	ETC-2
66	ETC-1	67	ETC-2
67	ETC-1	68	ETC-2
68	ETC-1	69	ETC-2
69	ETC-1	70	ETC-2
70	ETC-1	71	ETC-2
71	ETC-1	72	ETC-2
72	ETC-1	73	ETC-2
73	ETC-1	74	ETC-2
74	ETC-1	75	ETC-2
75	ETC-1	76	ETC-2
76	ETC-1	77	ETC-2
77	ETC-1	78	ETC-2
78	ETC-1	79	ETC-2
79	ETC-1	80	ETC-2
80	ETC-1	81	ETC-2
81	ETC-1	82	ETC-2
82	ETC-1	83	ETC-2
83	ETC-1	84	ETC-2
84	ETC-1	85	ETC-2
85	ETC-1	86	ETC-2
86	ETC-1	87	ETC-2
87	ETC-1	88	ETC-2
88	ETC-1	89	ETC-2
89	ETC-1	90	ETC-2
90	ETC-1	91	ETC-2
91	ETC-1	92	ETC-2
92	ETC-1	93	ETC-2
93	ETC-1	94	ETC-2
94	ETC-1	95	ETC-2
95	ETC-1	96	ETC-2
96	ETC-1	97	ETC-2
97	ETC-1	98	ETC-2
98	ETC-1	99	ETC-2
99	ETC-1	100	ETC-2

DRAFT

Scale: 1/8" = 1'-0" (Notes 1, 2, 3, 4, 5, 6, 7, 8, 9, 10, 11, 12, 13, 14, 15, 16, 17, 18, 19, 20, 21, 22, 23, 24, 25, 26, 27, 28, 29, 30, 31, 32, 33, 34, 35, 36, 37, 38, 39, 40, 41, 42, 43, 44, 45, 46, 47, 48, 49, 50, 51, 52, 53, 54, 55, 56, 57, 58, 59, 60, 61, 62, 63, 64, 65, 66, 67, 68, 69, 70, 71, 72, 73, 74, 75, 76, 77, 78, 79, 80, 81, 82, 83, 84, 85, 86, 87, 88, 89, 90, 91, 92, 93, 94, 95, 96, 97, 98, 99, 100, 101, 102, 103, 104, 105, 106, 107, 108, 109, 110, 111, 112, 113, 114, 115, 116, 117, 118, 119, 120, 121, 122, 123, 124, 125, 126, 127, 128, 129, 130, 131, 132, 133, 134, 135, 136, 137, 138, 139, 140, 141, 142, 143, 144, 145, 146, 147, 148, 149, 150, 151, 152, 153, 154, 155, 156, 157, 158, 159, 160, 161, 162, 163, 164, 165, 166, 167, 168, 169, 170, 171, 172, 173, 174, 175, 176, 177, 178, 179, 180, 181, 182, 183, 184, 185, 186, 187, 188, 189, 190, 191, 192, 193, 194, 195, 196, 197, 198, 199, 200, 201, 202, 203, 204, 205, 206, 207, 208, 209, 210, 211, 212, 213, 214, 215, 216, 217, 218, 219, 220, 221, 222, 223, 224, 225, 226, 227, 228, 229, 230, 231, 232, 233, 234, 235, 236, 237, 238, 239, 240, 241, 242, 243, 244, 245, 246, 247, 248, 249, 250, 251, 252, 253, 254, 255, 256, 257, 258, 259, 260, 261, 262, 263, 264, 265, 266, 267, 268, 269, 270, 271, 272, 273, 274, 275, 276, 277, 278, 279, 280, 281, 282, 283, 284, 285, 286, 287, 288, 289, 290, 291, 292, 293, 294, 295, 296, 297, 298, 299, 300, 301, 302, 303, 304, 305, 306, 307, 308, 309, 310, 311, 312, 313, 314, 315, 316, 317, 318, 319, 320, 321, 322, 323, 324, 325, 326, 327, 328, 329, 330, 331, 332, 333, 334, 335, 336, 337, 338, 339, 340, 341, 342, 343, 344, 345, 346, 347, 348, 349, 350, 351, 352, 353, 354, 355, 356, 357, 358, 359, 360, 361, 362, 363, 364, 365, 366, 367, 368, 369, 370, 371, 372, 373, 374, 375, 376, 377, 378, 379, 380, 381, 382, 383, 384, 385, 386, 387, 388, 389, 390, 391, 392, 393, 394, 395, 396, 397, 398, 399, 400, 401, 402, 403, 404, 405, 406, 407, 408, 409, 410, 411, 412, 413, 414, 415, 416, 417, 418, 419, 420, 421, 422, 423, 424, 425, 426, 427, 428, 429, 430, 431, 432, 433, 434, 435, 436, 437, 438, 439, 440, 441, 442, 443, 444, 445, 446, 447, 448, 449, 450, 451, 452, 453, 454, 455, 456, 457, 458, 459, 460, 461, 462, 463, 464, 465, 466, 467, 468, 469, 470, 471, 472, 473, 474, 475, 476, 477, 478, 479, 480, 481, 482, 483, 484, 485, 486, 487, 488, 489, 490, 491, 492, 493, 494, 495, 496, 497, 498, 499, 500, 501, 502, 503, 504, 505, 506, 507, 508, 509, 510, 511, 512, 513, 514, 515, 516, 517, 518, 519, 520, 521, 522, 523, 524, 525, 526, 527, 528, 529, 530, 531, 532, 533, 534, 535, 536, 537, 538, 539, 540, 541, 542, 543, 544, 545, 546, 547, 548, 549, 550, 551, 552, 553, 554, 555, 556, 557, 558, 559, 560, 561, 562, 563, 564, 565, 566, 567, 568, 569, 570, 571, 572, 573, 574, 575, 576, 577, 578, 579, 580, 581, 582, 583, 584, 585, 586, 587, 588, 589, 590, 591, 592, 593, 594, 595, 596, 597, 598, 599, 600, 601, 602, 603, 604, 605, 606, 607, 608, 609, 610, 611, 612, 613, 614, 615, 616, 617, 618, 619, 620, 621, 622, 623, 624, 625, 626, 627, 628, 629, 630, 631, 632, 633, 634, 635, 636, 637, 638, 639, 640, 641, 642, 643, 644, 645, 646, 647, 648, 649, 650, 651, 652, 653, 654, 655, 656, 657, 658, 659, 660, 661, 662, 663, 664, 665, 666, 667, 668, 669, 670, 671, 672, 673, 674, 675, 676, 677, 678, 679, 680, 681, 682, 683, 684, 685, 686, 687, 688, 689, 690, 691, 692, 693, 694, 695, 696, 697, 698, 699, 700, 701, 702, 703, 704, 705, 706, 707, 708, 709, 710, 711, 712, 713, 714, 715, 716, 717, 718, 719, 720, 721, 722, 723, 724, 725, 726, 727, 728, 729, 730, 731, 732, 733, 734, 735, 736, 737, 738, 739, 740, 741, 742, 743, 744, 745, 746, 747, 748, 749, 750, 751, 752, 753, 754, 755, 756, 757, 758, 759, 760, 761, 762, 763, 764, 765, 766, 767, 768, 769, 770, 771, 772, 773, 774, 775, 776, 777, 778, 779, 780, 781, 782, 783, 784, 785, 786, 787, 788, 789, 790, 791, 792, 793, 794, 795, 796, 797, 798, 799, 800, 801, 802, 803, 804, 805, 806, 807, 808, 809, 810, 811, 812, 813, 814, 815, 816, 817, 818, 819, 820, 821, 822, 823, 824, 825, 826, 827, 828, 829, 830, 831, 832, 833, 834, 835, 836, 837, 838, 839, 840, 841, 842, 843, 844, 845, 846, 847, 848, 849, 850, 851, 852, 853, 854, 855, 856, 857, 858, 859, 860, 861, 862, 863, 864, 865, 866, 867, 868, 869, 870, 871, 872, 873, 874, 875, 876, 877, 878, 879, 880, 881, 882, 883, 884, 885, 886, 887, 888, 889, 890, 891, 892, 893, 894, 895, 896, 897, 898, 899, 900, 901, 902, 903, 904, 905, 906, 907, 908, 909, 910, 911, 912, 913, 914, 915, 916, 917, 918, 919, 920, 921, 922, 923, 924, 925, 926, 927, 928, 929, 930, 931, 932, 933, 934, 935, 936, 937, 938, 939, 940, 941, 942, 943, 944, 945, 946, 947, 948, 949, 950, 951, 952, 953, 954, 955, 956, 957, 958, 959, 960, 961, 962, 963, 964, 965, 966, 967, 968, 969, 970, 971, 972, 973, 974, 975, 976, 977, 978, 979, 980, 981, 982, 983, 984, 985, 986, 987, 988, 989, 990, 991, 992, 993, 994, 995, 996, 997, 998, 999, 1000)

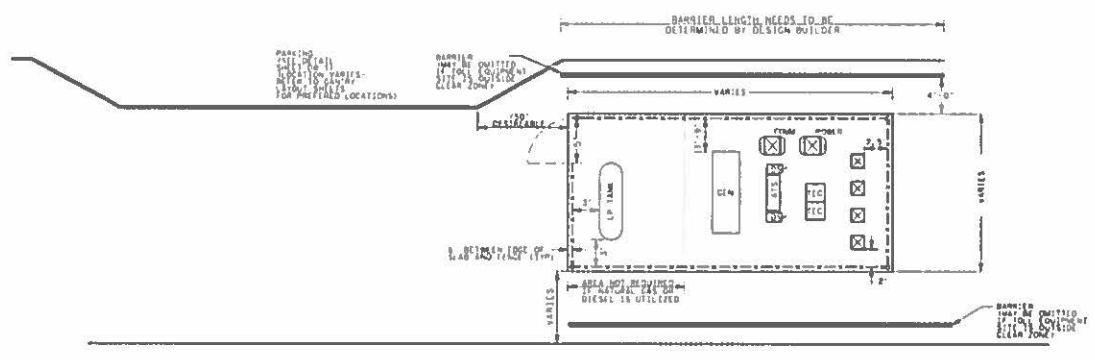

**DETAIL 1
EQUIPMENT PLACEMENT
AND DIMENSIONS**

- NOTES**
- 1) PARKING MAY BE LOCATED ON EITHER SIDE OF ROAD FUNCTIONS LAYOUTS MUST BE APPROVED BY MOBILITY AUTHORITY FOR APPROVAL.
 - 2) DESIGN BUILDER SHALL DESIGN SIGN FOUNDATION AND SUBMIT TO MOBILITY AUTHORITY FOR APPROVAL.
 - 3) DESIGN BUILDER SHALL PROVIDE ANCHOR DETAILS FOR ALL EQUIPMENT.
 - 4) TFC, FUEL TANK, GENERATOR, AND A/S TO BE PROVIDED BY SYSTEM INTEGRATOR.
 - 5) TFC SHALL HAVE FRONT AND REAR ACCESS LOCKABLE DOORS.
 - 6) TFC SHALL BE INSULATED WITH RE FLOOR INSULATION.
 - 7) TFC SHALL HAVE REDUNDANT ENVIRONMENTAL CONTROL.
 - 8) TFC SHALL HAVE INTRUSION DETECTION SYSTEM.
 - 9) 10' ALUMINUM LIGHT POLE AND LIGHTING ADD WITH MINIMUM 150 WATT METAL HALIDE 120V/240V OR EQUIVALENT LED OUTDOOR LIGHT FIXTURE WITH PHOTO CELL.
 - 10) DESIGN BUILDER SHALL BE RESPONSIBLE FOR PROVIDING PROTECTION FOR ALL EQUIPMENT PLACEMENT LOCATIONS.
 - 11) DESIGN BUILDER SHALL DETERMINE NUMBER OF SIZES, SIZE OF RISERS AND CONDUIT SHALL BE NEC TO MEET NEC AND AGG REQUIREMENTS.
 - 12) TFC CABINET TO BE DUAL 234 OR EQUIVALENT.
 - 13) ALL CONDUIT/PAL BOX SIZES AND MODELS MUST BE APPROVED BY THE MOBILITY AUTHORITY OR SYSTEMS INTEGRATOR.

INTERIM REVIEW ONLY

Reviewed by:	Date:
Checked by:	Date:

NOT TO SCALE

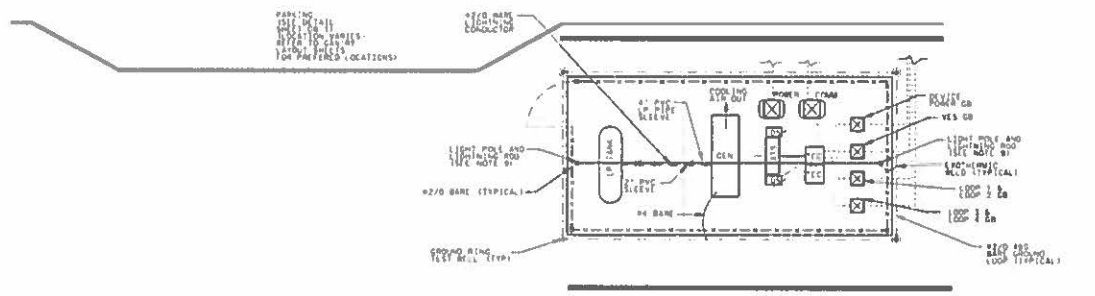

**DETAIL 2
EQUIPMENT PLACEMENT
AND ELECTRICAL RUNS**

HNTB
National Transportation
Engineering & Architecture
1000 Penn Plaza, Suite 900, DC, 20004

CONTRACT NO. 2011-11-01
Regional Mobility Authority

**FIXED PRICE
TOLLING STANDARDS
TOLL EQUIPMENT SITE
PLACEMENT DETAILS**

DATE	REVISION	BY	APP. NO.
10/20/11	1	J. S. [unclear]	1000000000
10/20/11	2	J. S. [unclear]	1000000000

DRAFT

GENERAL NOTES

- 1. JOINT DETAILS ARE PROVIDED ON THE JOINTED CONCRETE PAVEMENT (JC-1) STANDARD DETAIL SHEET.
- 2. SEE TERMINAL ANCHOR JOINT DETAIL FOR CRCP TO JCP PAVEMENT DETAIL ON SMT. 22. SEE CATD-1 FOR JCP TRANSITION TO ASPHALT.
- 3. TRANSVERSE JOINT SPACINGS ARE MEASURED ALONG THE OUTSIDE EDGE OF PAVEMENT. TRANSVERSE JOINTS SHALL BE RADIAL TO THE BASELINE.
- 4. PROVIDE BOTH MEMBRANE AND WET MAT CURING. ACE MEMBRANE CURING IMMEDIATELY AFTER TEXTURING. PROVIDE WET MAT CURING IN ACCORDANCE WITH TxDOT ITEM 420.201A. AFTER MEMBRANE CURING HAS BEEN APPLIED AND AS SOON AS PRACTICAL SO AS NOT TO DAMAGE THE SURFACE FINISH.
- 5. SAW JOINTS TO A DEPTH OF 3" ON THE PAVEMENT THICKNESS DIVIDED BY FOUR (4), WHICHEVER IS GREATER, AS SOON AS SAWING CAN BE ACCOMPLISHED WITH DRY WET BRELING AND COMPLETE SAWING BEFORE THE PAVEMENT BEGINS TO COOL. FOR EACH CONCRETE PLACEMENT INSTALL ONE OR MORE TEMPERATURE SENSORS, 1" BELOW THE SURFACE AND MONITOR TO INSURE TEMPERATURE REQUIREMENTS ARE MET.
- 6. DESIGN-BUILDER TO COORDINATE LOCATION OF CONSTRUCTION JOINTS WITH SYSTEM INTEGRATOR.
- 7. FOR 2 MAIN LANES, REMOVE L3. FOR 4 MAIN LANES, ADD L4.

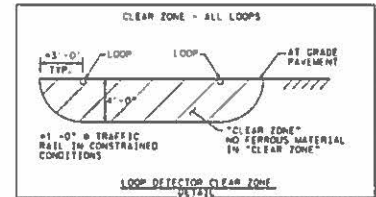

INTERIM REVIEW ONLY
 Issued for information only. Not for construction.
 Designer: JES 2, 06/19
 P. E. Number: 113131
 Date: 06/19/2013

HNTB
 HNTB Corporation
 The HNTB Companies
 National Highway Institute

401144-10000
 Regional Mobility Authority

FIXED PRICE
TOLLING STANDARDS
 MAINLINE PAVEMENT
 JOINTING PLAN
 AND GROUND
 BOX LAYOUT

Revised By:	10/20	Project No.:	113131
Drawn By:	06/19	Sheet No.:	11
Checked By:	06/19	Project Name:	113131
Scale:	AS SHOWN	Job No.:	113131
Date:	06/19	Project Manager:	113131

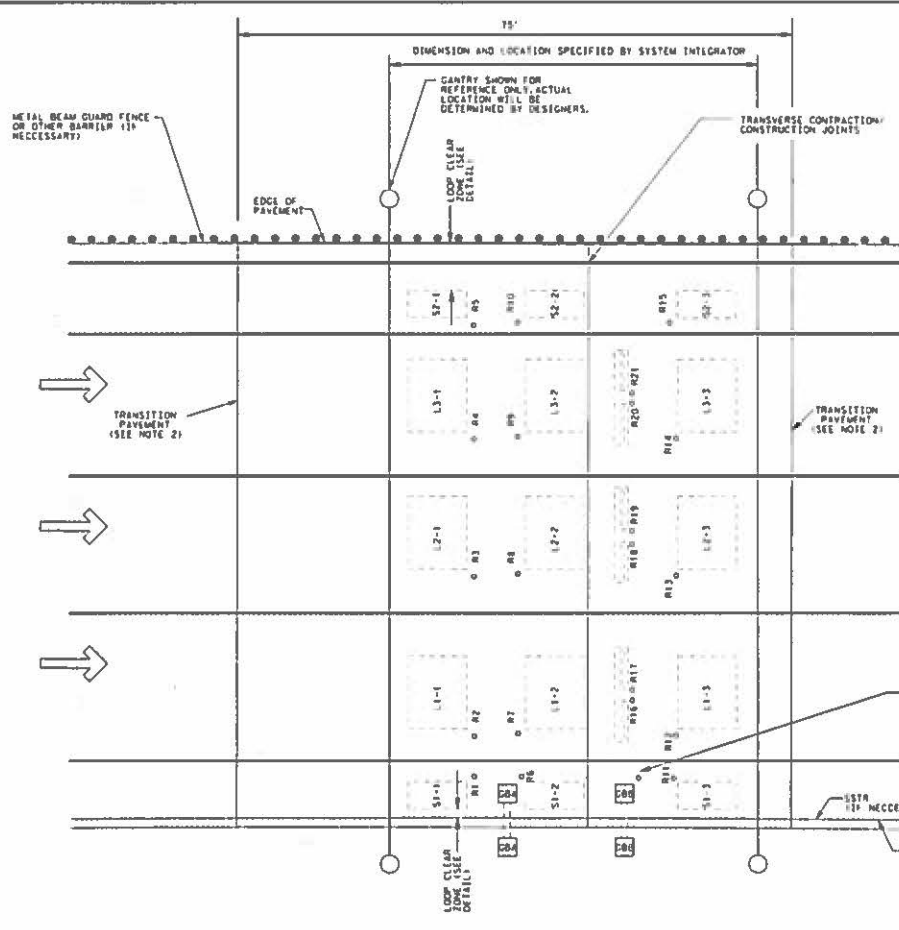

Project: 113131 - Mainline Pavement Jointing Standards
 Date: 06/19/2013
 Designer: JES 2
 P. E. Number: 113131
 Date: 06/19/2013

DRAFT

SAMPLE LOOP LAYOUT

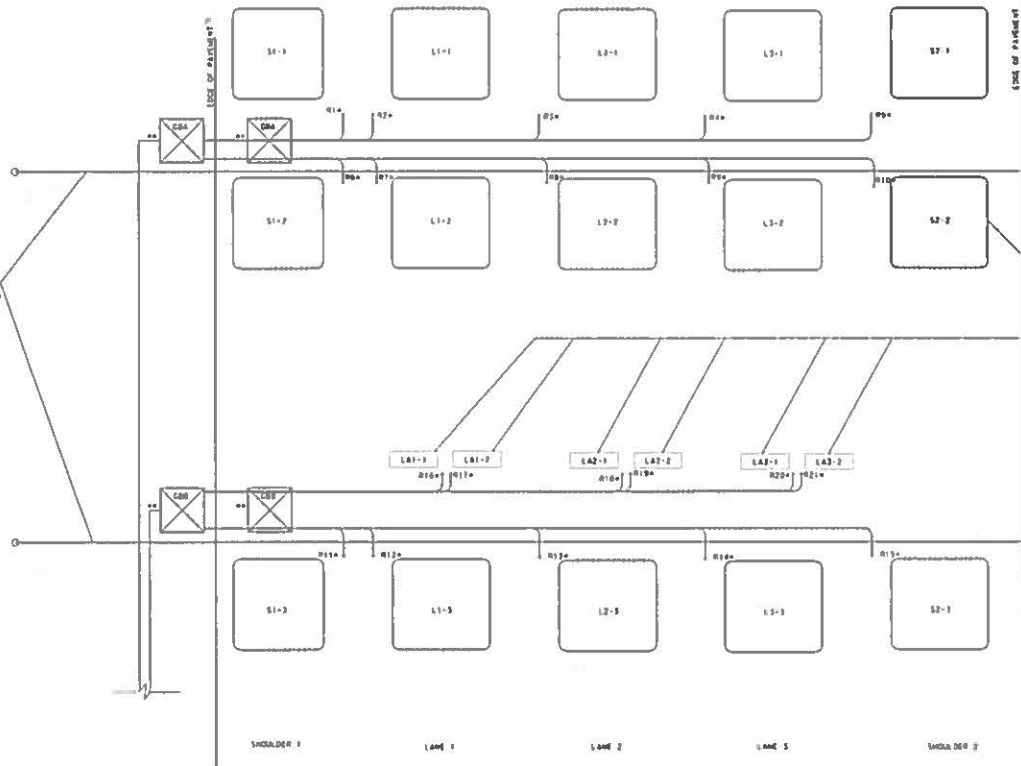

- GENERAL NOTES:
- 1) THE NUMBER AND LOCATION OF LOOPS AND RISERS TO BE SPECIFIED BY SYSTEM INTEGRATOR.
 - 2) NOT TO BE USED FOR LOOP PLACEMENT UNLESS LOOP LOCATION TO BE VERIFIED BY SURVEYOR.
 - 3) PVC SEE DETAIL 22 "CONDUIT RISER DETAIL LOOP RISE TO GROUND BOX CONDUIT TRENCH DETAIL".
 - 4) ADDITIONAL CIRC'S MAY BE REQUIRED COORDINATE NUMBER AND LOCATION WITH SYSTEMS INTEGRATOR.
 - 5) FOR 2 MAIN LANES, REMOVE L3 FOR A MAIN LANE.
 - 6) ALL GROUND BOX SIZES AND MODELS MUST BE APPROVED BY THE MOBILITY AUTHORITY OR SYSTEMS INTEGRATOR.
- SEE DETAIL 23 ON CONDUIT RISER DETAIL SHEET. RISER LOCATIONS TO BE SPECIFIED BY SYSTEMS INTEGRATOR.
 - SEE DETAIL 24 ON CONDUIT RISER DETAIL SHEET. RISER LOCATIONS FOR GROUND BOXES IS OUTSIDE OF PAVEMENT. IF INSUFFICIENT ROOM IS AVAILABLE OUTSIDE OF PAVEMENT, GROUND BOX SHALL BE NON-EMPIRIC RATED. IF GROUND BOX IS IN PAVEMENT, IT MUST BE NON-FERROUS.

AUTO RISERS
DESCRIPTION:
LOOP RISING

AUTO VEHICLE
CLASSIFICATION
CLASS

INTERIM REVIEW ONLY
Standard Implementation not intended for
partial, interim or subsequent
implementation. SEE 2.0 DESIGN
P.E. Number: 2272
Date: 10/20/2011

NOT TO SCALE



GENERAL CONTRACTOR
Regional Mobility Authority

FIXED PRICE
TOLLING STANDARDS
GROUND BOX PLACEMENT AND
CONDUIT RISER LOCATION
(MAIN LANES)

REVISION NO.	DATE	DESCRIPTION	BY	CHKD.
1	10/20/11	ISSUED FOR PROJECT NO. 2272		
2				
3				
4				
5				

HNTB, 11111 North Central Expressway, Suite 1111, Dallas, Texas 75243, Phone: (972) 968-8800, Fax: (972) 968-8801, www.hntb.com
 HNTB is an Equal Opportunity Employer. Minorities and women are encouraged to apply.

DRAFT

Project: I-10 Mainline Gantry Tolling Standards - Mainline Gantry Cross-Lane Tangent Elevation View
 Drawing No: 3-10-2015-001
 Date: 10/10/2015
 Author: J. [Name]
 Checker: [Name]
 Title: [Title]

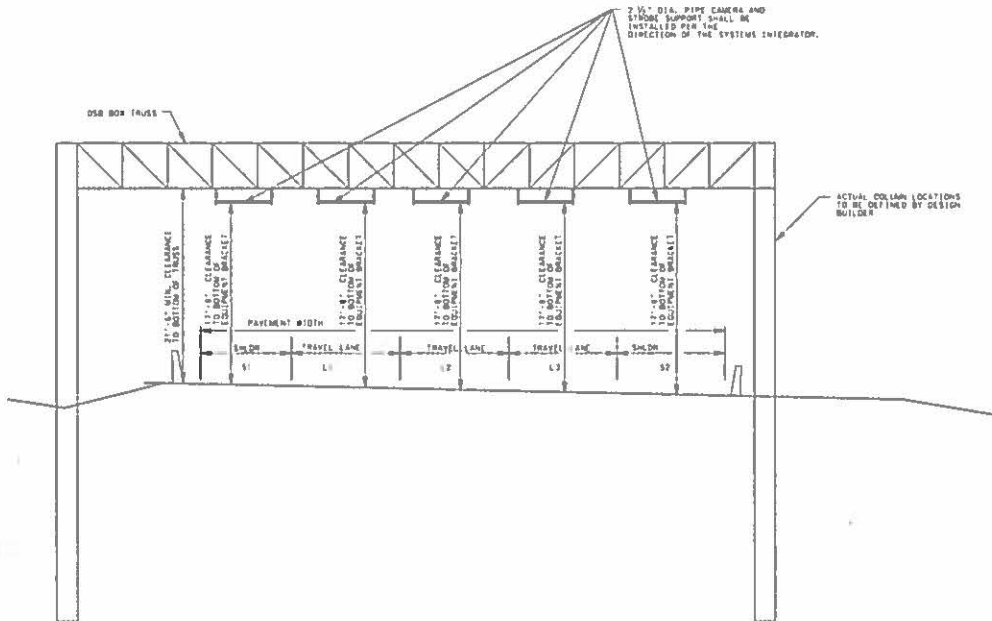

- NOTES**
1. TWO (2) BRACKETS ARE REQUIRED FOR EACH LOCATION SHOWN. BRACKETS SHALL BE ADJUSTABLE TO ALLOW FOR POSITIONING IN ACCORDANCE WITH THE SYSTEMS INTEGRATION'S SPECIFICATIONS. DESIGN BUILDER MUST COORDINATE INITIAL PLACEMENT LOCATION WITH THE SYSTEMS INTEGRATOR.
 2. BRACKETS ARE REQUIRED TO BE INSTALLED ON ALL GANTRY TRUSS. LOADERS ARE REQUIRED TO BE INSTALLED ON ALL GANTRY COLUMNS.
 3. FOR 2 MAIN LANES, REMOVE L.S. FOR 4 MAIN LANES, ADD L.S.

QUANTITY OF BRACKETS:
 2 LANES - 16 BRACKETS
 4 LANES - 32 BRACKETS

INTERIM REVIEW ONLY	
Design Engineer	_____ Date: 10/10/2015
Checker	_____ Date: 10/10/2015

NOT TO SCALE

HNTB HNTB Corporation
 Regional Mobility Authority
 10000 West 16th Avenue, Suite 1000, Denver, CO 80202

Central Texas
 Regional Mobility Authority

**FIXED PRICE
 TOLLING STANDARDS
 MAINLINE GANTRY CROSS-LANE
 TANGENT ELEVATION VIEW**

Project No.	3-10-2015-001	Revision	1
Client	Central Texas Regional Mobility Authority	Drawn By	J. [Name]
Checked By	[Name]	Date	10/10/2015

DRAFT

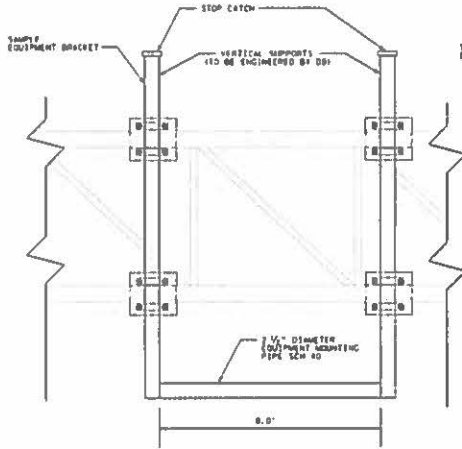

ELEVATION OF GANTRY BRACKET

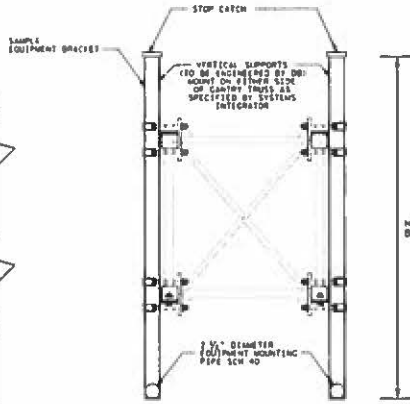

CROSS SECTION OF TOLL GANTRY BRACKET

GENERAL NOTES

- 1) THESE DETAILS ARE FOR USE WITH TOLL STANDING OVERHEAD SIGN BRIDGE (OSB) OR CANTILEVER OVERHEAD SIGN SUPPORT (COSS).
- 2) FOR CONNECTION DETAILS NOT SHOWN SEE OVERHEAD SIGN BRIDGE TRUSS DETAILS (OSBC) OR CANTILEVER OVERHEAD SIGN SUPPORT DETAILS (COSSD).
- 3) MATERIALS SHALL BE COMPATIBLE WITH THE REQUIREMENTS OF THE ASSOCIATED REFERENCE SIGN BRIDGE STANDARDS.
- 4) IDENTIFY OSB EQUIPMENT BRACKETS AND LOCATION TO BE SPECIFIED BY SYSTEMS INTEGRATOR.
- 5) DESIGN OF EQUIPMENT BRACKET AND CONNECTION TO OVERHEAD TRUSS TO BE PROVIDED BY DESIGN BUILDER. ALL ANTENNA AND CAMERA MOUNTING HARDWARE AND CONNECTION DETAILS TO BE PROVIDED BY SYSTEMS INTEGRATOR.
- 6) STOP BRACKETS FOR ALL ANTENNA AND WEBCAMERA SUPPORT SHALL BE PROVIDED FOR ENGINEER'S REVIEW.
- 7) DESIGN BUILDER TO SPECIFY APPROPRIATE SPAN, ICE LOADING, AND WIND LOAD TRUSS DYNAMIC RESPONSE AND DEFLECTION SHALL BE COMPATIBLE WITH TOLL SYSTEM REQUIREMENTS.
- 8) DESIGN OF OSB AND CORE COLUMN, DRILLED SHAFTS, AND TRUSS TO COLUMN CONNECTION TO BE PROVIDED BY DESIGN BUILDER.
- 9) EQUIPMENT BRACKET AND ALL MOUNTING HARDWARE SHALL BE HOT DIP GALVANIZED.

INTERIM REVIEW ONLY	
Design Approved and Issued For Permit, Building or Construction	Engineer: SHS P. HEIN
	Date: 11-04-2011

NOT TO SCALE

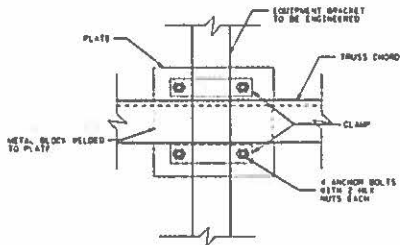

FRONT VIEW (TOP CHORD SHOWN, FLIP HORIZ. FOR BOTTOM CHORD)

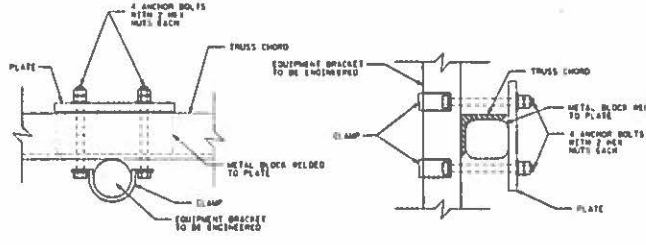

TOP VIEW (TOP CHORD SHOWN, BOTTOM VIEW FOR BOTTOM CHORD)

SIDE VIEW (TOP CHORD SHOWN, FLIP HORIZ. FOR BOTTOM CHORD)

HNTB HNTB Corporation
1400 North 17th Street
Phoenix, Arizona 85016
Phone: 602.998.0000
Fax: 602.998.0001

CONSULTING ENGINEER
Professional Seal

**FIXED PRICE
TOLLING STANDARDS
TOLL GANTRY
MISCELLANEOUS
DETAILS**

DATE: 11-04-2011	PROJECT NO: 11-001	SCALE: 1/4" = 1'-0"
DRAWN BY: SHS P. HEIN	CHECKED BY: JMS	DATE: 11-04-2011
APPROVED BY: SHS P. HEIN	DATE: 11-04-2011	

Note: For 2011 Tolling Standards, items 1400-1409, 1410-1419, 1420-1429, 1430-1439, 1440-1449, 1450-1459, 1460-1469, 1470-1479, 1480-1489, 1490-1499, 1500-1509, 1510-1519, 1520-1529, 1530-1539, 1540-1549, 1550-1559, 1560-1569, 1570-1579, 1580-1589, 1590-1599, 1600-1609, 1610-1619, 1620-1629, 1630-1639, 1640-1649, 1650-1659, 1660-1669, 1670-1679, 1680-1689, 1690-1699, 1700-1709, 1710-1719, 1720-1729, 1730-1739, 1740-1749, 1750-1759, 1760-1769, 1770-1779, 1780-1789, 1790-1799, 1800-1809, 1810-1819, 1820-1829, 1830-1839, 1840-1849, 1850-1859, 1860-1869, 1870-1879, 1880-1889, 1890-1899, 1900-1909, 1910-1919, 1920-1929, 1930-1939, 1940-1949, 1950-1959, 1960-1969, 1970-1979, 1980-1989, 1990-1999, 2000-2009, 2010-2019, 2020-2029, 2030-2039, 2040-2049, 2050-2059, 2060-2069, 2070-2079, 2080-2089, 2090-2099, 2100-2109, 2110-2119, 2120-2129, 2130-2139, 2140-2149, 2150-2159, 2160-2169, 2170-2179, 2180-2189, 2190-2199, 2200-2209, 2210-2219, 2220-2229, 2230-2239, 2240-2249, 2250-2259, 2260-2269, 2270-2279, 2280-2289, 2290-2299, 2300-2309, 2310-2319, 2320-2329, 2330-2339, 2340-2349, 2350-2359, 2360-2369, 2370-2379, 2380-2389, 2390-2399, 2400-2409, 2410-2419, 2420-2429, 2430-2439, 2440-2449, 2450-2459, 2460-2469, 2470-2479, 2480-2489, 2490-2499, 2500-2509, 2510-2519, 2520-2529, 2530-2539, 2540-2549, 2550-2559, 2560-2569, 2570-2579, 2580-2589, 2590-2599, 2600-2609, 2610-2619, 2620-2629, 2630-2639, 2640-2649, 2650-2659, 2660-2669, 2670-2679, 2680-2689, 2690-2699, 2700-2709, 2710-2719, 2720-2729, 2730-2739, 2740-2749, 2750-2759, 2760-2769, 2770-2779, 2780-2789, 2790-2799, 2800-2809, 2810-2819, 2820-2829, 2830-2839, 2840-2849, 2850-2859, 2860-2869, 2870-2879, 2880-2889, 2890-2899, 2900-2909, 2910-2919, 2920-2929, 2930-2939, 2940-2949, 2950-2959, 2960-2969, 2970-2979, 2980-2989, 2990-2999, 3000-3009, 3010-3019, 3020-3029, 3030-3039, 3040-3049, 3050-3059, 3060-3069, 3070-3079, 3080-3089, 3090-3099, 3100-3109, 3110-3119, 3120-3129, 3130-3139, 3140-3149, 3150-3159, 3160-3169, 3170-3179, 3180-3189, 3190-3199, 3200-3209, 3210-3219, 3220-3229, 3230-3239, 3240-3249, 3250-3259, 3260-3269, 3270-3279, 3280-3289, 3290-3299, 3300-3309, 3310-3319, 3320-3329, 3330-3339, 3340-3349, 3350-3359, 3360-3369, 3370-3379, 3380-3389, 3390-3399, 3400-3409, 3410-3419, 3420-3429, 3430-3439, 3440-3449, 3450-3459, 3460-3469, 3470-3479, 3480-3489, 3490-3499, 3500-3509, 3510-3519, 3520-3529, 3530-3539, 3540-3549, 3550-3559, 3560-3569, 3570-3579, 3580-3589, 3590-3599, 3600-3609, 3610-3619, 3620-3629, 3630-3639, 3640-3649, 3650-3659, 3660-3669, 3670-3679, 3680-3689, 3690-3699, 3700-3709, 3710-3719, 3720-3729, 3730-3739, 3740-3749, 3750-3759, 3760-3769, 3770-3779, 3780-3789, 3790-3799, 3800-3809, 3810-3819, 3820-3829, 3830-3839, 3840-3849, 3850-3859, 3860-3869, 3870-3879, 3880-3889, 3890-3899, 3900-3909, 3910-3919, 3920-3929, 3930-3939, 3940-3949, 3950-3959, 3960-3969, 3970-3979, 3980-3989, 3990-3999, 4000-4009, 4010-4019, 4020-4029, 4030-4039, 4040-4049, 4050-4059, 4060-4069, 4070-4079, 4080-4089, 4090-4099, 4100-4109, 4110-4119, 4120-4129, 4130-4139, 4140-4149, 4150-4159, 4160-4169, 4170-4179, 4180-4189, 4190-4199, 4200-4209, 4210-4219, 4220-4229, 4230-4239, 4240-4249, 4250-4259, 4260-4269, 4270-4279, 4280-4289, 4290-4299, 4300-4309, 4310-4319, 4320-4329, 4330-4339, 4340-4349, 4350-4359, 4360-4369, 4370-4379, 4380-4389, 4390-4399, 4400-4409, 4410-4419, 4420-4429, 4430-4439, 4440-4449, 4450-4459, 4460-4469, 4470-4479, 4480-4489, 4490-4499, 4500-4509, 4510-4519, 4520-4529, 4530-4539, 4540-4549, 4550-4559, 4560-4569, 4570-4579, 4580-4589, 4590-4599, 4600-4609, 4610-4619, 4620-4629, 4630-4639, 4640-4649, 4650-4659, 4660-4669, 4670-4679, 4680-4689, 4690-4699, 4700-4709, 4710-4719, 4720-4729, 4730-4739, 4740-4749, 4750-4759, 4760-4769, 4770-4779, 4780-4789, 4790-4799, 4800-4809, 4810-4819, 4820-4829, 4830-4839, 4840-4849, 4850-4859, 4860-4869, 4870-4879, 4880-4889, 4890-4899, 4900-4909, 4910-4919, 4920-4929, 4930-4939, 4940-4949, 4950-4959, 4960-4969, 4970-4979, 4980-4989, 4990-4999, 5000-5009, 5010-5019, 5020-5029, 5030-5039, 5040-5049, 5050-5059, 5060-5069, 5070-5079, 5080-5089, 5090-5099, 5100-5109, 5110-5119, 5120-5129, 5130-5139, 5140-5149, 5150-5159, 5160-5169, 5170-5179, 5180-5189, 5190-5199, 5200-5209, 5210-5219, 5220-5229, 5230-5239, 5240-5249, 5250-5259, 5260-5269, 5270-5279, 5280-5289, 5290-5299, 5300-5309, 5310-5319, 5320-5329, 5330-5339, 5340-5349, 5350-5359, 5360-5369, 5370-5379, 5380-5389, 5390-5399, 5400-5409, 5410-5419, 5420-5429, 5430-5439, 5440-5449, 5450-5459, 5460-5469, 5470-5479, 5480-5489, 5490-5499, 5500-5509, 5510-5519, 5520-5529, 5530-5539, 5540-5549, 5550-5559, 5560-5569, 5570-5579, 5580-5589, 5590-5599, 5600-5609, 5610-5619, 5620-5629, 5630-5639, 5640-5649, 5650-5659, 5660-5669, 5670-5679, 5680-5689, 5690-5699, 5700-5709, 5710-5719, 5720-5729, 5730-5739, 5740-5749, 5750-5759, 5760-5769, 5770-5779, 5780-5789, 5790-5799, 5800-5809, 5810-5819, 5820-5829, 5830-5839, 5840-5849, 5850-5859, 5860-5869, 5870-5879, 5880-5889, 5890-5899, 5900-5909, 5910-5919, 5920-5929, 5930-5939, 5940-5949, 5950-5959, 5960-5969, 5970-5979, 5980-5989, 5990-5999, 6000-6009, 6010-6019, 6020-6029, 6030-6039, 6040-6049, 6050-6059, 6060-6069, 6070-6079, 6080-6089, 6090-6099, 6100-6109, 6110-6119, 6120-6129, 6130-6139, 6140-6149, 6150-6159, 6160-6169, 6170-6179, 6180-6189, 6190-6199, 6200-6209, 6210-6219, 6220-6229, 6230-6239, 6240-6249, 6250-6259, 6260-6269, 6270-6279, 6280-6289, 6290-6299, 6300-6309, 6310-6319, 6320-6329, 6330-6339, 6340-6349, 6350-6359, 6360-6369, 6370-6379, 6380-6389, 6390-6399, 6400-6409, 6410-6419, 6420-6429, 6430-6439, 6440-6449, 6450-6459, 6460-6469, 6470-6479, 6480-6489, 6490-6499, 6500-6509, 6510-6519, 6520-6529, 6530-6539, 6540-6549, 6550-6559, 6560-6569, 6570-6579, 6580-6589, 6590-6599, 6600-6609, 6610-6619, 6620-6629, 6630-6639, 6640-6649, 6650-6659, 6660-6669, 6670-6679, 6680-6689, 6690-6699, 6700-6709, 6710-6719, 6720-6729, 6730-6739, 6740-6749, 6750-6759, 6760-6769, 6770-6779, 6780-6789, 6790-6799, 6800-6809, 6810-6819, 6820-6829, 6830-6839, 6840-6849, 6850-6859, 6860-6869, 6870-6879, 6880-6889, 6890-6899, 6900-6909, 6910-6919, 6920-6929, 6930-6939, 6940-6949, 6950-6959, 6960-6969, 6970-6979, 6980-6989, 6990-6999, 7000-7009, 7010-7019, 7020-7029, 7030-7039, 7040-7049, 7050-7059, 7060-7069, 7070-7079, 7080-7089, 7090-7099, 7100-7109, 7110-7119, 7120-7129, 7130-7139, 7140-7149, 7150-7159, 7160-7169, 7170-7179, 7180-7189, 7190-7199, 7200-7209, 7210-7219, 7220-7229, 7230-7239, 7240-7249, 7250-7259, 7260-7269, 7270-7279, 7280-7289, 7290-7299, 7300-7309, 7310-7319, 7320-7329, 7330-7339, 7340-7349, 7350-7359, 7360-7369, 7370-7379, 7380-7389, 7390-7399, 7400-7409, 7410-7419, 7420-7429, 7430-7439, 7440-7449, 7450-7459, 7460-7469, 7470-7479, 7480-7489, 7490-7499, 7500-7509, 7510-7519, 7520-7529, 7530-7539, 7540-7549, 7550-7559, 7560-7569, 7570-7579, 7580-7589, 7590-7599, 7600-7609, 7610-7619, 7620-7629, 7630-7639, 7640-7649, 7650-7659, 7660-7669, 7670-7679, 7680-7689, 7690-7699, 7700-7709, 7710-7719, 7720-7729, 7730-7739, 7740-7749, 7750-7759, 7760-7769, 7770-7779, 7780-7789, 7790-7799, 7800-7809, 7810-7819, 7820-7829, 7830-7839, 7840-7849, 7850-7859, 7860-7869, 7870-7879, 7880-7889, 7890-7899, 7900-7909, 7910-7919, 7920-7929, 7930-7939, 7940-7949, 7950-7959, 7960-7969, 7970-7979, 7980-7989, 7990-7999, 8000-8009, 8010-8019, 8020-8029, 8030-8039, 8040-8049, 8050-8059, 8060-8069, 8070-8079, 8080-8089, 8090-8099, 8100-8109, 8110-8119, 8120-8129, 8130-8139, 8140-8149, 8150-8159, 8160-8169, 8170-8179, 8180-8189, 8190-8199, 8200-8209, 8210-8219, 8220-8229, 8230-8239, 8240-8249, 8250-8259, 8260-8269, 8270-8279, 8280-8289, 8290-8299, 8300-8309, 8310-8319, 8320-8329, 8330-8339, 8340-8349, 8350-8359, 8360-8369, 8370-8379, 8380-8389, 8390-8399, 8400-8409, 8410-8419, 8420-8429, 8430-8439, 8440-8449, 8450-8459, 8460-8469, 8470-8479, 8480-8489, 8490-8499, 8500-8509, 8510-8519, 8520-8529, 8530-8539, 8540-8549, 8550-8559, 8560-8569, 8570-8579, 8580-8589, 8590-8599, 8600-8609, 8610-8619, 8620-8629, 8630-8639, 8640-8649, 8650-8659, 8660-8669, 8670-8679, 8680-8689, 8690-8699, 8700-8709, 8710-8719, 8720-8729, 8730-8739, 8740-8749, 8750-8759, 8760-8769, 8770-8779, 8780-8789, 8790-8799, 8800-8809, 8810-8819, 8820-8829, 8830-8839, 8840-8849, 8850-8859, 8860-8869, 8870-8879, 8880-8889, 8890-8899, 8900-8909, 8910-8919, 8920-8929, 8930-8939, 8940-8949, 8950-8959, 8960-8969, 8970-8979, 8980-8989, 8990-8999, 9000-9009, 9010-9019, 9020-9029, 9030-9039, 9040-9049, 9050-9059, 9060-9069, 9070-9079, 9080-9089, 9090-9099, 9100-9109, 9110-9119, 9120-9129, 9130-9139, 9140-9149, 9150-9159, 9160-9169, 9170-9179, 9180-9189, 9190-9199, 9200-9209, 9210-9219, 9220-9229, 9230-9239, 9240-9249, 9250-9259, 9260-9269, 9270-9279, 9280-9289, 9290-9299, 9300-9309, 9310-9319, 9320-9329, 9330-9339, 9340-9349, 9350-9359, 9360-9369, 9370-9379, 9380-9389, 9390-9399, 9400-9409, 9410-9419, 9420-9429, 9430-9439, 9440-9449, 9450-9459, 9460-9469, 9470-9479, 9480-9489, 9490-9499, 9500-9509, 9510-9519, 9520-9529, 9530-9539, 9540-9549, 9550-9559, 9560-9569, 9570-9579, 9580-9589, 9590-9599, 9600-9609, 9610-9619, 9620-9629, 9630-9639, 9640-9649, 9650-9659, 9660-9669, 9670-9679, 9680-9689, 9690-9699, 9700-9709, 9710-9719, 9720-9729, 9730-9739, 9740-9749, 9750-9759, 9760-9769, 9770-9779, 9780-9789, 9790-9799, 9800-9809, 9810-9819, 9820-9829, 9830-9839, 9840-9849, 9850-9859, 9860-9869, 9870-9879, 9880-9889, 9890-9899, 9900-9909, 9910-9919, 9920-9929, 9930-9939, 9940-9949, 9950-9959, 9960-9969, 9970-9979, 9980-9989, 9990-9999, 1000-1009, 1010-1019, 1020-1029, 1030-1039, 1040-1049, 1050-1059, 1060-1069, 1070-1079, 1080-1089, 1090-1099, 1100-1109, 1110-1119, 1120-1129, 1130-1139, 1140-1149, 1150-1159, 1160-1169, 1170-1179, 1180-1189, 1190-1199, 1200-1209, 1210-1219, 1220-1229, 1230-1239, 1240-1249, 1250-1259, 1260-1269, 1270-1279, 1280-1289, 1290-1299, 1300-1309, 1310-1319, 1320-1329, 1330-1339, 1340-1349, 1350-1359, 1360-1369, 1370-1379, 1380-1389, 1390-1399, 1400-1409, 1410-1419, 1420-1429, 1430-1439, 1440-1449, 1450-1459, 1460-1469, 1470-1479, 1480-1489, 1490-1499, 1500-1509, 1510-1519, 1520-1529, 1530-1539, 1540-1549, 1550-1559, 1560-1569, 1570-1579, 1580-1589, 1590-1599, 1600-1609, 1610-1619, 1620-1629, 1630-1639, 1640-1649, 1650-1659, 1660-1669, 1670-1679, 1680-1689, 1690-1699, 1700-1709, 1710-1719, 1720-1729, 1730-1739, 1740-1749, 1750-1759, 1760-1769, 1770-1779, 1780-1789, 1790-1799, 1800-1809, 1810-1819, 1820-1829, 1830-1839, 1840-1849, 1850-1859, 1860-1869, 1870-1879, 1880-1889, 1890-1899, 1900-1909, 1910-1919, 1920-1929, 1930-1939, 1940-1949, 1950-1959, 1960-1969, 1970-1979, 1980-1

DRAFT

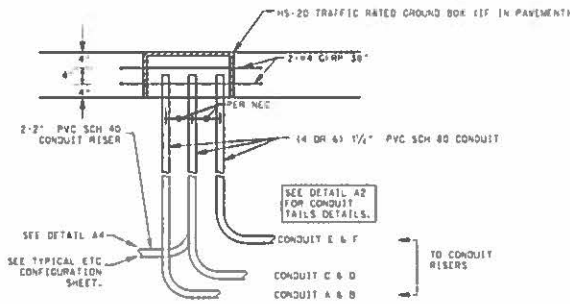

CONDUIT RISER DETAIL A1
LOOP TAIL TO GROUND BOX
CONDUIT TRENCH DETAIL

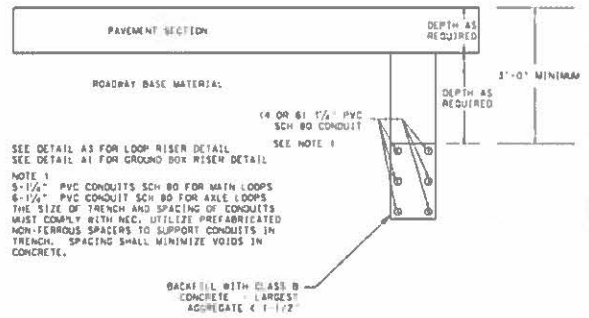

CONDUIT RISER DETAIL A2
LOOP TAIL TO GROUND BOX
CONDUIT TRENCH DETAIL

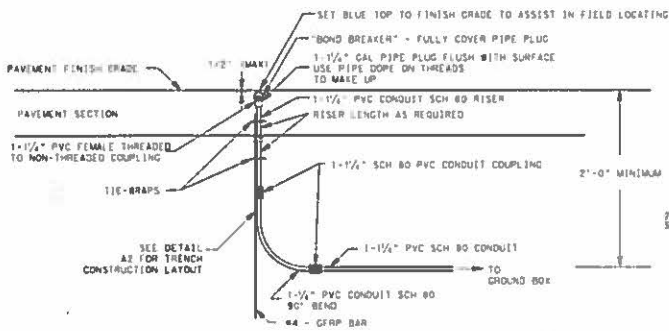

CONDUIT RISER DETAIL A3
LOOP TAIL TO GROUND BOX
CONDUIT LOOP RISER DETAIL

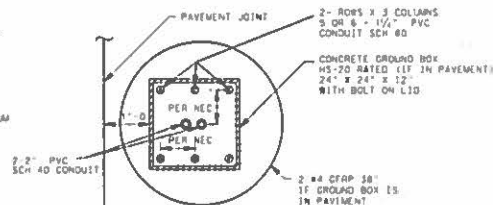

DETAIL A4

INTERVIEW REVIEW ONLY
DESIGNER: [Signature]
DATE: 10/13/10
PROJECT: [Project Name]

NOT TO SCALE

HNTB CONSULTANTS
11000 West Alameda Avenue, Suite 1000
Denver, Colorado 80202
Tel: 303.733.1100

CONTRACT NO. 10000
Regional Mobility Authority

**FIXED PRICE
TOLLING STANDARDS
CONDUIT RISER
DETAILS**

DATE: 10/13/10	BY: [Signature]	REVISED: [Signature]	DATE: [Signature]
DESIGNED BY: [Signature]	CHECKED BY: [Signature]	APPROVED BY: [Signature]	DATE: [Signature]
DATE: [Signature]	BY: [Signature]	DATE: [Signature]	BY: [Signature]

HNTB CONSULTANTS, A DIVISION OF HNTB GROUP, INC., 11000 WEST ALAMEDA AVENUE, SUITE 1000, DENVER, COLORADO 80202
 PROJECT: [Project Name]
 SHEET: [Sheet Number]
 DATE: [Date]

DRAFT

HNTB is the design consultant for the project. HNTB is not responsible for the design of the equipment or the installation of the equipment. HNTB is not responsible for the design of the equipment or the installation of the equipment. HNTB is not responsible for the design of the equipment or the installation of the equipment.

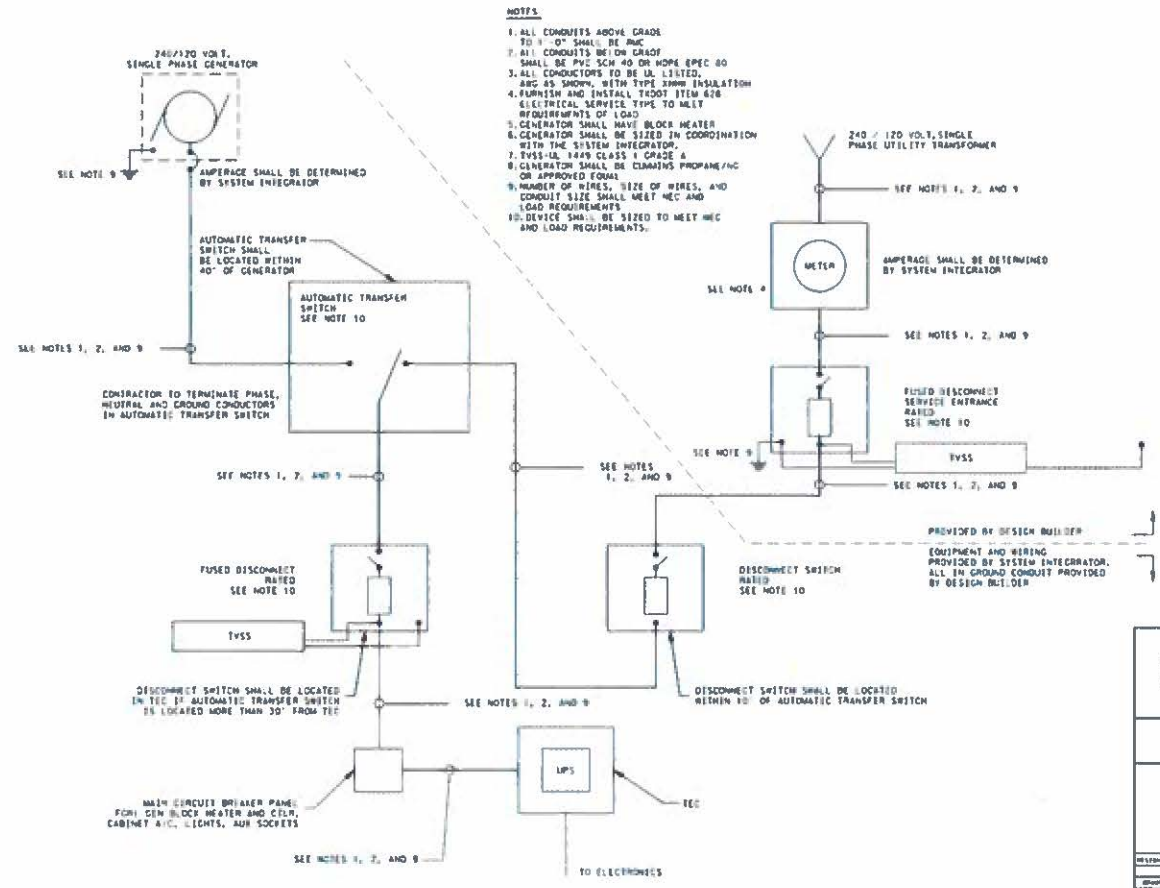

- NOTES**
1. ALL CONDUITS ABOVE GRADE TO 1" O" SHALL BE RMC
 2. ALL CONDUITS BELOW GRADE SHALL BE PVC SCH 40 OR MOPC EPEC 80
 3. ALL CONDUCTORS TO BE UL LISTED, 800 AS SHOWN, WITH TYPE 9000 INSULATION
 4. FURNISH AND INSTALL TCCOT ITEM 618 ELECTRICAL SERVICE TYPE TO MEET REQUIREMENTS OF LOAD
 5. GENERATOR SHALL HAVE BLOCK HEATER
 6. GENERATOR SHALL BE SIZED IN COORDINATION WITH THE SYSTEM INTEGRATOR
 7. PVSS-UL 1449 CLASS 1 GRADE A
 8. GENERATOR SHALL BE CLAIMING PROPANE/NG OR APPROVED EQUAL
 9. NUMBER OF WIRES, SIZE OF WIRES, AND CONDUIT SIZE SHALL MEET NEC AND LOAD REQUIREMENTS
 10. DEVICE SHALL BE SIZED TO MEET NEC AND LOAD REQUIREMENTS.

INTERIM REVIEW ONLY
 HNTB
 10/15/2020

HNTB HNTB Corporation
 Regional Mobility Authority

FIXED PRICE TOLLING STANDARDS TOLL GANTRY ELECTRICAL SINGLE-LINE DRAWING

DETAILS			
REVISION NO.	DATE	DESCRIPTION	BY
1	10/15/2020	ISSUE FOR REVIEW	JL

ATTACHMENT E

PRICE SHEET SH-71

Toll System Installation/Integration

Task No.	Description	Qty	Unit	Unit Price (US \$'s)	Extended Price (US \$'s)	Equipment / Subcontractors	Labor	Markup on Sub's & Equipment	%	Total	Total Hours
1	HW - Materials / Equipment	1	Lot	495,840.11	495,840.11	413,200		82,640	20.0%	495,840	
2	Program Management	1	Lot	222,566.37	222,566.37		222,566			222,566	1,187
3	SW Design & System Documentation	1	Lot	129,354.18	129,354.18		129,354			129,354	860
4	SW Development	1	Lot	71,340.92	71,340.92		71,341			71,341	480
5	SW Integration/Test (Commissioning, Final Accept, etc.)	1	Lot	182,348.02	182,348.02		182,348			182,348	1,220
6	Installation	1	Lot	305,968.26	305,968.26	115,500	167,368	23,100	20.0%	305,968	1,394
7	Fiber-1: CTRMA	1	Lot	149,352.13	149,352.13	115,050	11,292	23,010	20.0%	149,352	73
8	Fiber-2: TxDOT	1	Lot	476,490.38	476,490.38	361,757	42,382	72,351	20.0%	476,490	275
9	Bonding	1	LS	26,234.13	26,234.13	26,234				26,234	
TOTAL					2,059,495	1,031,741	826,652	201,101		2,059,495	5,490

The Pricing shown above Excludes:

- All Recurring Data Communication Costs
- Recurring 3rd-Party SW/HW Support Agreements & SW Licenses
- Spares Replenishment Costs
- Excludes System HW/SW Warranty/Maintenance Services & Support
- Excludes MOT for Toll System Installation (Includes MOT for Fiber Installation)

Item	Description	Quantity	Unit	Material	Notes	Estimate #	Estimate Date	Estimate Value	Estimate Status
1	Concrete Slab	100	sq ft	100		100	100	100	100
2	Rebar	100	lb	100		100	100	100	100
3	Formwork	100	sq ft	100		100	100	100	100
4	Gravel	100	cu yd	100		100	100	100	100
5	Asphalt	100	sq ft	100		100	100	100	100
6	Paint	100	gal	100		100	100	100	100
7	Electric	100	hr	100		100	100	100	100
8	Plumbing	100	hr	100		100	100	100	100
9	Mechanical	100	hr	100		100	100	100	100
10	Roofing	100	sq ft	100		100	100	100	100
11	Landscaping	100	hr	100		100	100	100	100
12	Site Work	100	hr	100		100	100	100	100
13	Foundation	100	sq ft	100		100	100	100	100
14	Walls	100	sq ft	100		100	100	100	100
15	Floors	100	sq ft	100		100	100	100	100
16	Roofs	100	sq ft	100		100	100	100	100
17	Windows	100	sq ft	100		100	100	100	100
18	Doors	100	sq ft	100		100	100	100	100
19	Interior	100	sq ft	100		100	100	100	100
20	Exterior	100	sq ft	100		100	100	100	100
21	Site Prep	100	hr	100		100	100	100	100
22	Excavation	100	cu yd	100		100	100	100	100
23	Backfill	100	cu yd	100		100	100	100	100
24	Compaction	100	sq ft	100		100	100	100	100
25	Grading	100	sq ft	100		100	100	100	100
26	Drainage	100	sq ft	100		100	100	100	100
27	Retaining	100	sq ft	100		100	100	100	100
28	Foundation	100	sq ft	100		100	100	100	100
29	Walls	100	sq ft	100		100	100	100	100
30	Floors	100	sq ft	100		100	100	100	100
31	Roofs	100	sq ft	100		100	100	100	100
32	Windows	100	sq ft	100		100	100	100	100
33	Doors	100	sq ft	100		100	100	100	100
34	Interior	100	sq ft	100		100	100	100	100
35	Exterior	100	sq ft	100		100	100	100	100
36	Site Prep	100	hr	100		100	100	100	100
37	Excavation	100	cu yd	100		100	100	100	100
38	Backfill	100	cu yd	100		100	100	100	100
39	Compaction	100	sq ft	100		100	100	100	100
40	Grading	100	sq ft	100		100	100	100	100
41	Drainage	100	sq ft	100		100	100	100	100
42	Retaining	100	sq ft	100		100	100	100	100
43	Foundation	100	sq ft	100		100	100	100	100
44	Walls	100	sq ft	100		100	100	100	100
45	Floors	100	sq ft	100		100	100	100	100
46	Roofs	100	sq ft	100		100	100	100	100
47	Windows	100	sq ft	100		100	100	100	100
48	Doors	100	sq ft	100		100	100	100	100
49	Interior	100	sq ft	100		100	100	100	100
50	Exterior	100	sq ft	100		100	100	100	100

Labor Rates

	Partial CY2014 yr-4 Esc
Position Title	2.5%
Software Engineer	\$139.62
System Engineer	\$152.86
Technician	\$107.12
Database Administrator	\$198.59
Documentation Clerk	\$143.23
Testing Engineer	\$151.65
Network Engineer	\$138.41
Project Manager	\$198.59
Blended PW Technician Rate	\$126.25

SW Integration/Test

	Total hrs
Database Administrator	
Database Developer	200
Software Engineer - Image Processing	-
Software Engineer - Real Time	160
Software Manager	120
Software Programmer - Web/Middle Tier	200
Documentation / Technical Writer / CAD	
Project Manger	80
System Engineer	40
Test / QA Manager	80
Test Engineer	320
Field Tech Team Lead / Supervisor	
Field Technician	
Installation/Field Manager	
Client Account Manager (Maint)	
Network / Systems Administrator	120
Software Support (Maint)	

Notes: Includes the set up of the machines, configuration and testing of the network, set up of the reports, commission test, and operational test.

CTRMA/TxDOT FIBER INSTALLATION SH 71

ITEM CODE	DESCRIPTION	UNIT	Total	
			CTRMA	TxDOT
610-2031	Comm Cable (6 Pair) (22AWG)	LF	0	31300
620-2018	Elec Condr (No 14) Insulated	LF	6000	9300
618-2022	Conduit PVC (3")	LF	440	0
6014-2011	Fiber Optic Cable (Single-Mode)(12 Fiber)	LF	710	63660
6014-2014	Fiber Optic Cable (Single-Mode)(48 Fiber)	LF	18125	16400
6014-2020	Fiber Optic Splice Enclosure	EA	1	0
6014-2021	Fiber Optic Patch (12 Position)	EA	0	14
6014-20XX	Fibr Patch Panel (24 Position)	EA	1	1
6014-2022	Fiber Patch Panel (48 Position)	EA	0	0
6014-20XX	Fiber Patch Panel (72 Position)	EA	0	2
	SFP (SM)	EA	6	6
	Interconnect Cabinet	EA	1	0
	Cabinet Foundation	CY	1	0

Assumptions:

1. The fiber design for TxDOT is based on the Austin District's current method of ITS installation which provides a dedicated fiber to each device.
 - a. TxDOT does not allow mid-entry splices to their fiber trunk
 - b. Because of (a.) - A new Communications Hub building is needed to integrated all fiber runs to one central location on the corridor
 - c. The new Comm Hub building for this estimated is located at the underpass of Sprit of Texas and SH-71.
 - d. The estimate does not include the cost of procuring or installing a new Comm Hub building, it considers this design item as a D/B provided item.
 - e. Each CCTV camera has a dedicated fiber cable and a dedicated twisted pair comm. cable from the Camera to the single Hub building
 - f. Each DMS has a dedicated fiber cable from the DMS to the single Hub building.
2. An Interface cabinet for interconnecting the TxDOT trunk and the CTRMA trunk along SH-71 to the proposed CTRMA/TxDOT shared fiber trunk along SH-130 is included in the estimate under CTRMA costs.
3. TxDOT and CTRMA will have separate trunks along SH-71.

DRAFT

Toll System Implementation
Work Authorization No. 12

ATTACHMENT F

PRELIMINARY PROJECT SCHEDULE AND MILESTONES

State Highway 71 Toll Lanes

(Dates and Durations Subject to Change)

Task	Duration and/or Milestone Date
Design-Build Contract Executed	August 2014
Construction Duration (Approximate)	2 years
Open to Traffic	Winter 2016

